

ARNO[®]

Kofler[®]

ARNO[®]

WERKZEUGE

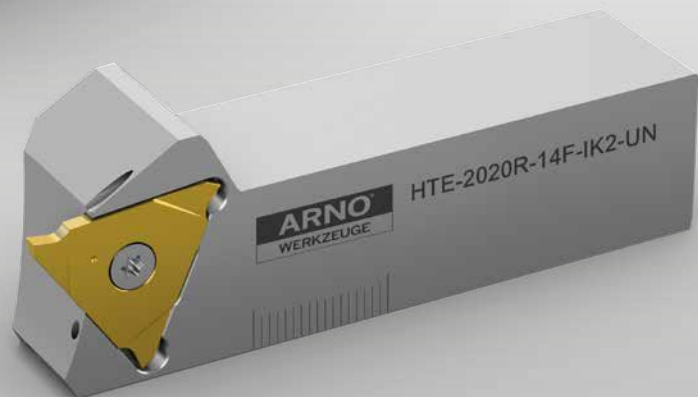

ATS-System – vielseitig bei kurzen, präzisen Einstichen.

ATS System – versatile for short precision grooves.

Sistema ATS – versatile nella realizzazione di scanalature corte e precise.

SYSTEM ATS

Metall Kofler GmbH
AUT - 6166 Fulpmes | Industriezone B14
office@mkofler.at | +43 5225 62712
www.mkofler.at

HERAUSRAGEND FÜR MEHR PRODUKTIVITÄT IN IHRER FERTIGUNG.

Sie haben herausfordernde Zerspanungsaufgaben? Wir haben herausragende Lösungen! Bereits seit drei Generationen entwickeln wir Werkzeugsysteme, die durch Qualität, Langlebigkeit und Prozesssicherheit überzeugen. Als ARNO Kunde profitieren Sie von der Mischung aus Erfahrung und Pioniergeist, die unser Familienunternehmen seit jeher auszeichnet. Wir sind typisch schwäbische Tüftler und stolz darauf, unseren Kunden mit cleveren Neu- und Weiterentwicklungen auch in Zukunft entscheidende Wettbewerbsvorteile zu sichern.

OUTSTANDING FOR MORE PRODUCTIVITY IN YOUR PRODUCTION.

Do you have challenging machining tasks? We have outstanding solutions. For three generations, we have been developing tool systems which have outstanding quality, long tool life and process reliability. As an ARNO customer you benefit from a combination of experience and pioneering spirit. Besides these values we are also influenced by the typical Swabian talent for inventiveness. We are proud to assist our customers to secure that extra competitive advantage with clever new developments and advancements and we will continue along this path in the future.

ECCEZIONALE PER UNA MIGLIORE PRODUTTIVITÀ NELLA TUA PRODUZIONE.

Avete obiettivi di lavorazione macchina ambiziosi? Noi abbiamo soluzioni eccezionali adatte ai tuoi scopi. Per tre generazioni abbiamo sviluppato sistemi utensili di qualità eccezionale, lunga durata dell'utensile e affidabilità del processo. Come clienti ARNO avete la possibilità di beneficiare di una combinazione di esperienza e di spirito pionieristico. Oltre a questi valori siamo anche influenzati dal tipico talento Svevo per l'inventiva. Siamo orgogliosi di supportare i nostri clienti assicurando questo vantaggio competitivo con sempre nuove ed innovative soluzioni e lo faremo sempre anche in futuro.

SYSTEM ATS

- 04 - 05 **Systemvorstellung** / *System presentation* / Caratteristiche del sistema
- 06 **Bezeichnungssystem** / *Designation system* / Sistema di identificazione
- 07 **Werkzeugauswahl** / *Tool shank options* / Tipologie di corpo utensil
- 08 - 15 **Monoblockhalter** / *Monoblock holders* / Utensili monoblocco
- 16 - 19 **Monoblockhalter auf KMH-Werkzeugaufnahmen (VDI)** / *Monoblock holders with KMH-holder (VDI)* / Adattatore KMH (VDI) per utensili monoblocco
- 21 **Anfrage Halter ATS mit Sonderabmessungen** / *Enquiry holder ATS with special dimensions* / Richiesta utensili ATS con dimensioni speciali
- 22 - 23 **Systemvorstellung** / *System presentation* / Caratteristiche del sistema
- 24 **Klemmhalter mit Schraubenklammung für Langdrehautomaten** / *Holders with screw clamping for sliding head auto lathes* / Steli con fissaggio a vite per fantina mobile
- 25 **Geometriebeschreibung und Sortenbeschreibung** / *Geometry description and Grade discription* / Descriptione delle Geometria e Descrizione della Qualità
- 26 - 30 **Schneideinsätze** / *Inserts* / Inerti
- 31 - 33 **Empfohlene Schnittwerte** / *Recommended cutting data* / Parametri di taglio suggeriti
- 34 **Anwendungshinweise** / *Application reference* / Suggerimenti tecnici
-

Vielseitig bei präzisen Einstichen: das neue ATS-System von ARNO. *Versatile for precise parting off: the new ATS System from ARNO.* Versatile nella realizzazione di scanalature precise: il nuovo sistema ATS di ARNO.

Wirtschaftlich dank dreischneidiger Schneidplatten, schnell beim Werkzeugwechsel und stabil durch die Torx-Plus Schraubenklemmung mit optimalem Form- und Kraftschluss: Das ATS Werkzeugsystem zum Außenstechen hat viele Stärken. Vielseitigkeit gehört ebenfalls dazu: Durch die versenkte Klemmschraube und die kompakte Bauform können Sie das ATS-System auch beim Schulterstechen oder im Langdrehbereich einsetzen. Für eine reibungslose Spanabfuhr und hohe Standzeiten sorgt die optimierte Kühlmittelzufuhr der Halter auf die Span- und Freifläche.

Efficient thanks to 3-edged inserts; fast tool changes and rigid due to the Torx-Plus screw clamping system to offer optimised clamping and insert location: The ATS tool system for external parting off has many strengths. One of them is versatility: the countersunk clamping screw and the compact design make the ATS system ideal for applications like shoulder grooving or Swiss type machining. The optimised coolant supply to the cutting edge and tool flank ensure smooth chip evacuation and long tool life.

Economico grazie agli inserti a tre taglienti, veloce al cambio utensile e stabile grazie al bloccaggio a vite Torx-Plus con bloccaggio con accoppiamento dinamico e geometrico ottimale: Il sistema per utensili ATS per l'incisione esterna ha molti punti di forza. Uno di questi è la versatilità: Grazie alla vite di serraggio a testa svasata e alla struttura compatta, è possibile utilizzare il sistema ATS anche per scanalatura di spallamenti o nella tornitura cilindrica. L'adduzione del refrigerante ottimizzata, integrata nel supporto sulla superficie di spoglia superiore e sul fianco garantisce una evacuazione dei trucioli regolare e una lunga durata.

Standard: direkte Kühlung der Spanfläche
Standard: direct cooling of the cutting edge
Standard: raffreddamento diretto della superficie di spoglia superiore

Optimale Positioniergenauigkeit durch komplett geschliffene Ausführung
Optimal positioning accuracy due to the completely periphery grinding
Precisione di posizionamento ottimale grazie al design completamente rettificato

Standard: optimale Kühlung der Freifläche
Standard: optimised cooling of the tool flank
Standard: raffreddamento ottimale del fianco

Geeignet zum Stechen an der Schulter
Suitable for grooving at the shoulder
Adatto per la scanalatura degli spallamenti

Stechsystem mit 3-schneidiger T-Wendeschneidplatte
Grooving system with T-shaped indexable insert with 3 cutting edges
Sistema di scanalatura con inserto a 3 taglienti

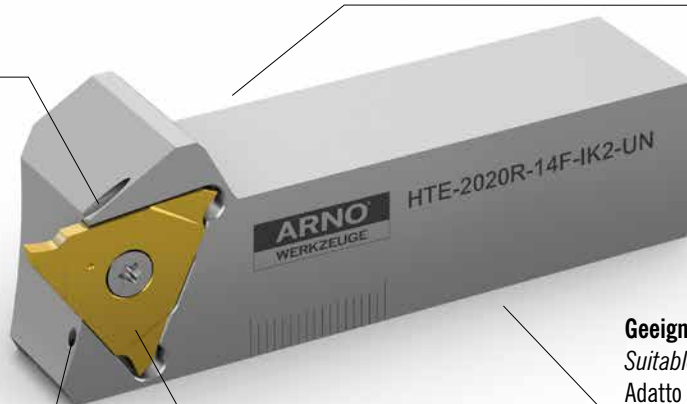

Toleranz Einstechbreite EB ±0,02 mm
Tolerance groove width EB ±0,02 mm
 Larghezza gola tolleranza EB ±0,02 mm

Geometrie -GA mit 8° Spanwinkel
Geometry -GA with 8° rake angle
 Geometria -GA, angolo di spoglia superiore di 8°

Geschliffene Auflagefläche
Ground contact surface
 Superficie di appoggio rettificata

Universelle Hochleistungs-Sorte AP5020
Universal high-performance grade AP5020
 Varietà universale ad alte prestazioni AP5020

Geschliffene Anlageflächen
Ground contact surfaces
 Superfici di appoggio

Einstehtiefe ET max. 6,5 mm
Cutting depths up to ET = 6.5 mm
 Profondità di scanalatura fino a ET = 6,5 mm

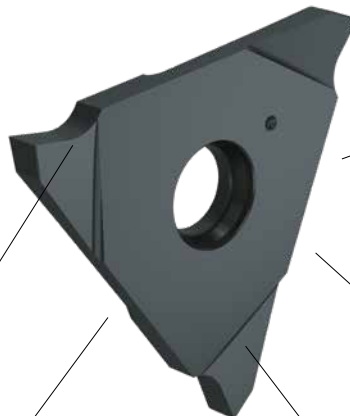

Verfügbar in den Formen B1 bis B4 und C1 bis C4
Available in a variety of shapes from B1 to B4 and from C1 to C4
 Disponibile in diverse forme da B1 a B4 e da C1 a C4

Zusätzliche Kühlung über Kühlmitteldüse
Coolant jet for additional cooling
 Refrigerante addizionale attraverso il ugello

VDI-Schaft
VDI-Shank
 Attacco VDI

Eine Schnittstelle weniger für mehr Prozesssicherheit: Trägerwerkzeug und KMH-Werkzeugaufnahme passen perfekt zusammen
One interface less for more process reliability: Tool holder and KMH holder fit together perfectly
 Un elemento in meno per garantire maggiore sicurezza di processo: L'utensile e il adattori KMH si adattano perfettamente

Längeneinstellung über definierten Bereich
The tool holder can be adjusted within the defined scales
 Regolazione della lunghezza attraverso marcatura sul portautensile

Zielgerichtete Kühlmittelübergabe für sichere Prozesse
Efficient coolant supply for reliable processes
 Passaggio mirato del liquido refrigerante, processi sicuri

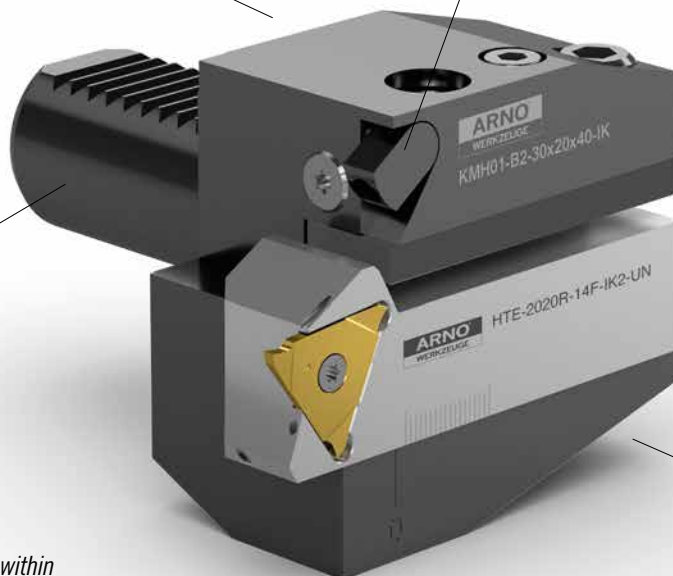

Monoblockhalter / Monoblock holders / Utensili monoblocco

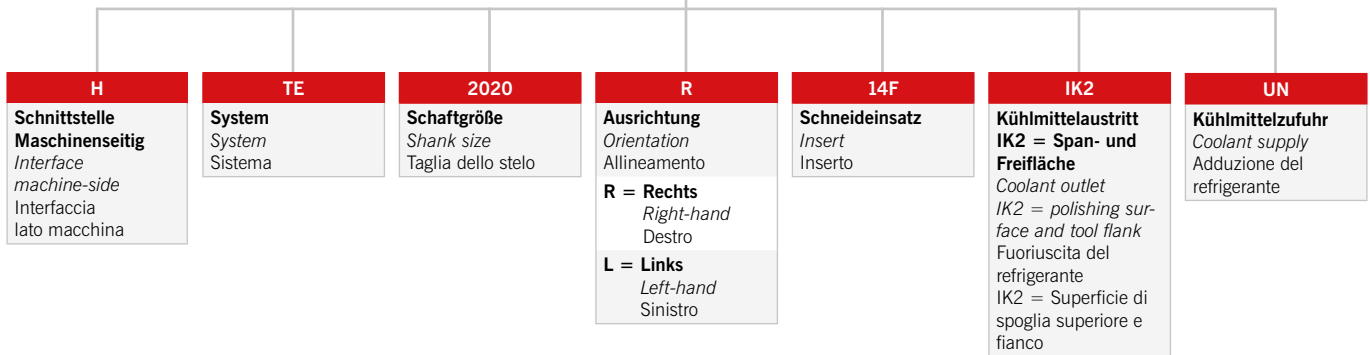
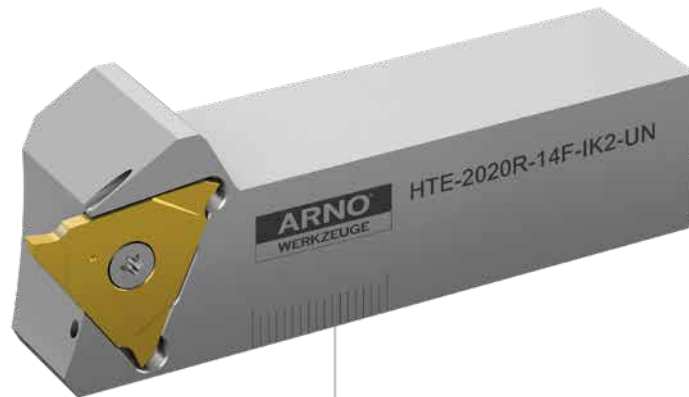

Schneideinsätze / Inserts / Inserti

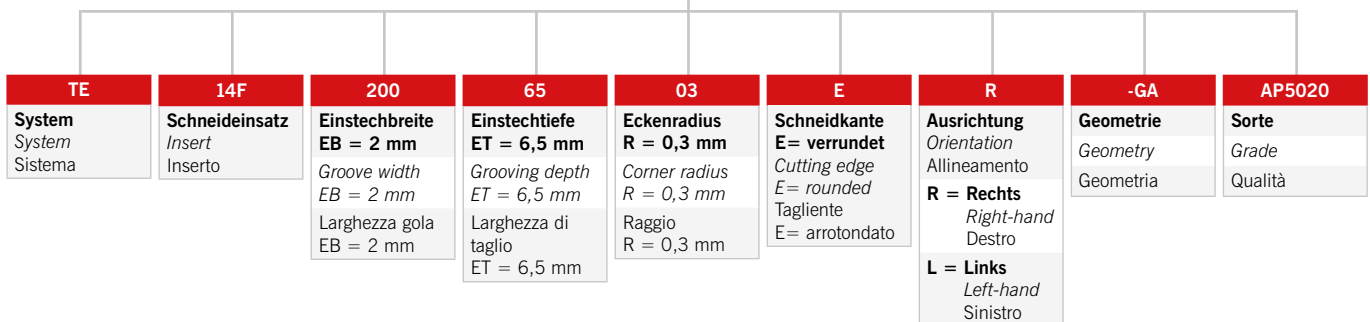

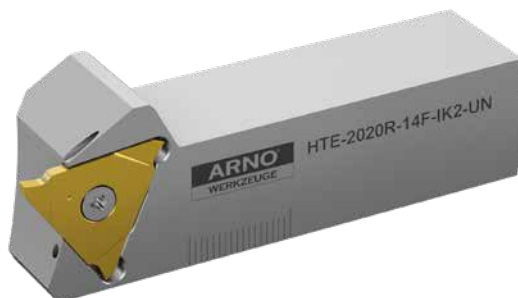

Monoblockhalter HTE / Monoblock holders HTE / Utensili monoblocco HTE

Seite/Page/Pagina **08–15**



KMH-Werkzeughalter (VDI) / KMH-Holders (VDI) / Adattatore KMH (VDI)

Seite/Page/Pagina **16–19**



Schneideinsätze / Inserts / Inserti

Seite/Page/Pagina **25–29**

HTE-...-IK2-H...

Monoblockhalter mit Innenkühlung IK2 von hinten

Monoblock holder with through tool coolant (IK2) access from the back

Utensile monoblocco con adduzione interna IK2 posteriore

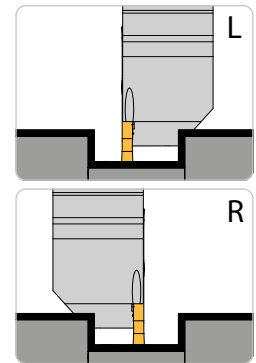
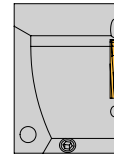
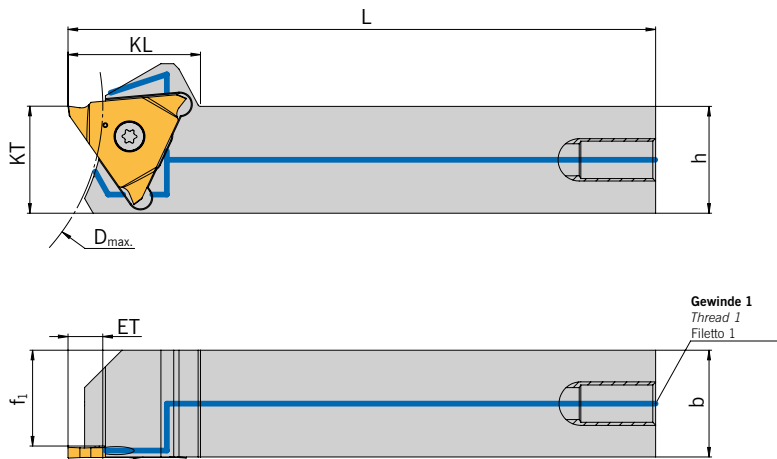

Rechte Ausführung abgebildet
Right-hand execution shown
Versione destra in figura

Trägerwerkzeuge / Holders / Utensili

Ausführung H1 = Gewinde M8x1 / Execution H1 = Thread M8x1 / Esecuzione H1 = filetto M8x1

Bezeichnung Designation Articolo	ET	D _{max}	h	b	L	f ₁	KL	KT	Gewinde 1 Thread 1 Filetto 1	Größe Size Ampiezza	Schneideinsatz Insert Inserto
HTE-1212L/R-14F-IK2-H1	6,5	80	12	12	110	9,95	25	20	M8x1	F	T...14F-...
HTE-1212L/R-14H-IK2-H1	6,5	80	12	12	110	8,95	25	20	M8x1	H	T...14H-...
HTE-1212L/R-14K-IK2-H1	6,5	80	12	12	110	7,95	25	20	M8x1	K	T...14K-...
HTE-1616L/R-14F-IK2-H1	6,5	80	16	16	110	13,95	25	20	M8x1	F	T...14F-...
HTE-1616L/R-14H-IK2-H1	6,5	80	16	16	110	12,95	25	20	M8x1	H	T...14H-...
HTE-1616L/R-14K-IK2-H1	6,5	80	16	16	110	11,95	25	20	M8x1	K	T...14K-...
HTE-2020L/R-14F-IK2-H1	6,5	80	20	20	110	17,95	25	± h	M8x1	F	T...14F-...
HTE-2020L/R-14H-IK2-H1	6,5	80	20	20	110	16,95	25	± h	M8x1	H	T...14H-...
HTE-2020L/R-14K-IK2-H1	6,5	80	20	20	110	15,95	25	± h	M8x1	K	T...14K-...
HTE-2525L/R-14F-IK2-H1	6,5	150	25	25	110	22,95	25	± h	M8x1	F	T...14F-...
HTE-2525L/R-14H-IK2-H1	6,5	150	25	25	110	21,95	25	± h	M8x1	H	T...14H-...
HTE-2525L/R-14K-IK2-H1	6,5	150	25	25	110	20,95	25	± h	M8x1	K	T...14K-...
HTE-2525L/R-14P-IK2-H1	6,5	150	25	25	110	19,95	25	± h	M8x1	P	T...14P-...
HTE-2525L/R-14S-IK2-H1	6,5	150	25	25	110	18,95	25	± h	M8x1	S	T...14S-...

Ausführung H2 = Gewinde G1/8" / Execution H2 = Thread G1/8" / Esecuzione H2 = filetto G1/8"

Bezeichnung Designation Articolo	ET	D _{max}	h	b	L	f ₁	KL	KT	Gewinde 1 Thread 1 Filetto 1	Größe Size Ampiezza	Schneideinsatz Insert Inserto
HTE-1212L/R-14F-IK2-H2	6,5	80	12	12	110	9,95	25	20	G1/8"	F	T...14F-...
HTE-1212L/R-14H-IK2-H2	6,5	80	12	12	110	8,95	25	20	G1/8"	H	T...14H-...
HTE-1212L/R-14K-IK2-H2	6,5	80	12	12	110	7,95	25	20	G1/8"	K	T...14K-...
HTE-1616L/R-14F-IK2-H2	6,5	80	16	16	110	13,95	25	20	G1/8"	F	T...14F-...
HTE-1616L/R-14H-IK2-H2	6,5	80	16	16	110	12,95	25	20	G1/8"	H	T...14H-...
HTE-1616L/R-14K-IK2-H2	6,5	80	16	16	110	11,95	25	20	G1/8"	K	T...14K-...
HTE-2020L/R-14F-IK2-H2	6,5	80	20	20	110	17,95	25	± h	G1/8"	F	T...14F-...
HTE-2020L/R-14H-IK2-H2	6,5	80	20	20	110	16,95	25	± h	G1/8"	H	T...14H-...
HTE-2020L/R-14K-IK2-H2	6,5	80	20	20	110	15,95	25	± h	G1/8"	K	T...14K-...
HTE-2525L/R-14F-IK2-H2	6,5	150	25	25	110	22,95	25	± h	G1/8"	F	T...14F-...
HTE-2525L/R-14H-IK2-H2	6,5	150	25	25	110	21,95	25	± h	G1/8"	H	T...14H-...
HTE-2525L/R-14K-IK2-H2	6,5	150	25	25	110	20,95	25	± h	G1/8"	K	T...14K-...
HTE-2525L/R-14P-IK2-H2	6,5	150	25	25	110	19,95	25	± h	G1/8"	P	T...14P-...
HTE-2525L/R-14S-IK2-H2	6,5	150	25	25	110	18,95	25	± h	G1/8"	S	T...14S-...

Ausführung H3 = Gewinde G1/4" / Execution H3 = Thread G1/4" / Esecuzione H3 = filetto G1/4"

Bezeichnung Designation Articolo	ET	D _{max}	h	b	L	f ₁	KL	KT	Gewinde 1 Thread 1 Filetto 1	Größe Size Ampiezza	Schneideinsatz Insert Inserto
HTE-1616L/R-14F-IK2-H3	6,5	80	16	16	110	13,95	25	20	G1/4"	F	T...14F-...
HTE-1616L/R-14H-IK2-H3	6,5	80	16	16	110	12,95	25	20	G1/4"	H	T...14H-...
HTE-1616L/R-14K-IK2-H3	6,5	80	16	16	110	11,95	25	20	G1/4"	K	T...14K-...
HTE-2020L/R-14F-IK2-H3	6,5	80	20	20	110	17,95	25	± h	G1/4"	F	T...14F-...
HTE-2020L/R-14H-IK2-H3	6,5	80	20	20	110	16,95	25	± h	G1/4"	H	T...14H-...
HTE-2020L/R-14K-IK2-H3	6,5	80	20	20	110	15,95	25	± h	G1/4"	K	T...14K-...
HTE-2525L/R-14F-IK2-H3	6,5	150	25	25	110	22,95	25	± h	G1/4"	F	T...14F-...
HTE-2525L/R-14H-IK2-H3	6,5	150	25	25	110	21,95	25	± h	G1/4"	H	T...14H-...
HTE-2525L/R-14K-IK2-H3	6,5	150	25	25	110	20,95	25	± h	G1/4"	K	T...14K-...
HTE-2525L/R-14P-IK2-H3	6,5	150	25	25	110	19,95	25	± h	G1/4"	P	T...14P-...
HTE-2525L/R-14S-IK2-H3	6,5	150	25	25	110	18,95	25	± h	G1/4"	S	T...14S-...

ARNO® SpecialDesign

Diese Monoblockhalter bekommen Sie mit Ihren spezifischen Kühlschlüssen. Ein Anfrageblatt hierzu finden Sie auf Seite 21 oder im Internet unter: www.arno.de/service/downloads
Bitte beachten Sie den Hinweis zur Verwendung des Halters auf KMH-Werkzeugaufnahme (VDI) auf den Seiten 16–19!

The coolant inlet can be supplied to your specification, please complete enquiry sheet on page 21 or download this from: www.arno.de/service/downloads.

Please refer to notes for using KMH tool holder (VDI) on page 16–19!

Per altre richieste compilare modulo a pag. 21 o scaricarlo da: www.arno.de/service/downloads. Vedere i suggerimenti di utilizzo degli adattatori KMH (VDI) a pagina 16–19!

Ersatzteile / Spare Parts / Ricambi

Trägerwerkzeug / Holder / Utensile	Schraube / Screw / Vite	Drehmoment / Torque / Coppia	Schlüssel / Key / Chiave
HTE-...-14...	AS 0005	2,5 Nm	T5210-IP

HTE-...-IK2-S...

Monoblockhalter mit Innenkühlung IK2 von der Seite

Monoblock holder with through tool coolant (IK2) access from the side

Utensile monoblocco con adduzione interna IK2 laterale

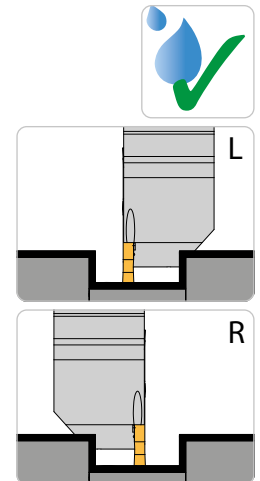
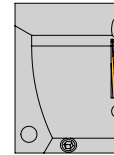
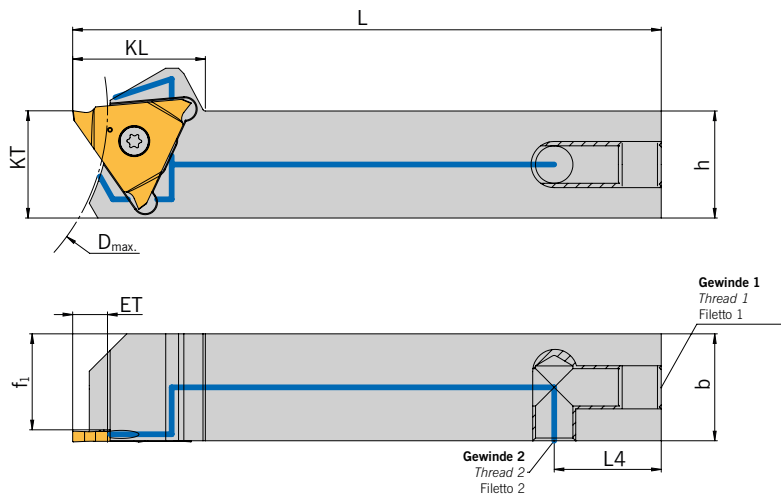

Rechte Ausführung abgebildet
Right-hand execution shown
Versione destra in figura

Trägerwerkzeuge / Holders / Utensili

Ausführung S1 = Gewinde 1: M8x1, Gewinde 2: M8x1 / Execution S1 = Thread 1 M8x1, Thread 2 M8x1 /
Esecuzione S1 = filetto 1 M8x1, filetto 2 M8x1

Bezeichnung Designation Articolo	ET	D _{max}	h	b	L	f ₁	KL	KT	L ₄	Gewinde 1 Thread 1 Filetto 1	Gewinde 2 Thread 2 Filetto 2	Größe Size Ampiezza	Schneideinsatz Insert Inserito
HTE-1212L/R-14F-IK2-S1	6,5	80	12	12	110	9,95	25	20	20	M8x1	M8x1	F	T...14F-...
HTE-1212L/R-14H-IK2-S1	6,5	80	12	12	110	8,95	25	20	20	M8x1	M8x1	H	T...14H-...
HTE-1212L/R-14K-IK2-S1	6,5	80	12	12	110	7,95	25	20	20	M8x1	M8x1	K	T...14K-...
HTE-1616L/R-14F-IK2-S1	6,5	80	16	16	110	13,95	25	20	20	M8x1	M8x1	F	T...14F-...
HTE-1616L/R-14H-IK2-S1	6,5	80	16	16	110	12,95	25	20	20	M8x1	M8x1	H	T...14H-...
HTE-1616L/R-14K-IK2-S1	6,5	80	16	16	110	11,95	25	20	20	M8x1	M8x1	K	T...14K-...
HTE-2020L/R-14F-IK2-S1	6,5	80	20	20	110	17,95	25	± h	20	M8x1	M8x1	F	T...14F-...
HTE-2020L/R-14H-IK2-S1	6,5	80	20	20	110	16,95	25	± h	20	M8x1	M8x1	H	T...14H-...
HTE-2020L/R-14K-IK2-S1	6,5	80	20	20	110	15,95	25	± h	20	M8x1	M8x1	K	T...14K-...
HTE-2525L/R-14F-IK2-S1	6,5	150	25	25	110	22,95	25	± h	20	M8x1	M8x1	F	T...14F-...
HTE-2525L/R-14H-IK2-S1	6,5	150	25	25	110	21,95	25	± h	20	M8x1	M8x1	H	T...14H-...
HTE-2525L/R-14K-IK2-S1	6,5	150	25	25	110	20,95	25	± h	20	M8x1	M8x1	K	T...14K-...
HTE-2525L/R-14P-IK2-S1	6,5	150	25	25	110	19,95	25	± h	20	M8x1	M8x1	P	T...14P-...
HTE-2525L/R-14S-IK2-S1	6,5	150	25	25	110	18,95	25	± h	20	M8x1	M8x1	S	T...14S-...

Ausführung S2 = Gewinde 1: M8x1, Gewinde 2: G1/8" / Execution S2 = Thread 1: M8x1, Thread 2: G1/8" /
Esecuzione S2 = filetto 1: M8x1, filetto 2: G1/8"

Bezeichnung Designation Articolo	ET	D _{max}	h	b	L	f ₁	KL	KT	L ₄	Gewinde 1 Thread 1 Filetto 1	Gewinde 2 Thread 2 Filetto 2	Größe Size Ampiezza	Schneideinsatz Insert Inserto
HTE-1212L/R-14F-IK2-S2	6,5	80	12	12	110	9,95	25	20	20	M8x1	G1/8"	F	T...14F-...
HTE-1212L/R-14H-IK2-S2	6,5	80	12	12	110	8,95	25	20	20	M8x1	G1/8"	H	T...14H-...
HTE-1212L/R-14K-IK2-S2	6,5	80	12	12	110	7,95	25	20	20	M8x1	G1/8"	K	T...14K-...
HTE-1616L/R-14F-IK2-S2	6,5	80	16	16	110	13,95	25	20	20	M8x1	G1/8"	F	T...14F-...
HTE-1616L/R-14H-IK2-S2	6,5	80	16	16	110	12,95	25	20	20	M8x1	G1/8"	H	T...14H-...
HTE-1616L/R-14K-IK2-S2	6,5	80	16	16	110	11,95	25	20	20	M8x1	G1/8"	K	T...14K-...
HTE-2020L/R-14F-IK2-S2	6,5	80	20	20	110	17,95	25	± h	20	M8x1	G1/8"	F	T...14F-...
HTE-2020L/R-14H-IK2-S2	6,5	80	20	20	110	16,95	25	± h	20	M8x1	G1/8"	H	T...14H-...
HTE-2020L/R-14K-IK2-S2	6,5	80	20	20	110	15,95	25	± h	20	M8x1	G1/8"	K	T...14K-...
HTE-2525L/R-14F-IK2-S2	6,5	150	25	25	110	22,95	25	± h	20	M8x1	G1/8"	F	T...14F-...
HTE-2525L/R-14H-IK2-S2	6,5	150	25	25	110	21,95	25	± h	20	M8x1	G1/8"	H	T...14H-...
HTE-2525L/R-14K-IK2-S2	6,5	150	25	25	110	20,95	25	± h	20	M8x1	G1/8"	K	T...14K-...
HTE-2525L/R-14P-IK2-S2	6,5	150	25	25	110	19,95	25	± h	20	M8x1	G1/8"	P	T...14P-...
HTE-2525L/R-14S-IK2-S2	6,5	150	25	25	110	18,95	25	± h	20	M8x1	G1/8"	S	T...14S-...

ARNO® SpecialDesign

Diese Monoblockhalter bekommen Sie mit Ihren spezifischen Kühlschlüssen. Ein Anfrageblatt hierzu finden Sie auf Seite 21 oder im Internet unter: www.arno.de/service/downloads
Bitte beachten Sie den Hinweis zur Verwendung des Halters auf KMH-Werkzeugaufnahme (VDI) auf den Seiten 16–19!

The coolant inlet can be supplied to your specification, please complete enquiry sheet on page 21 or download this from: www.arno.de/service/downloads.

Please refer to notes for using KMH tool holder (VDI) on page 16–19!

Per altre richieste compilare modulo a pag. 21 o scaricarlo da: www.arno.de/service/downloads. Vedere i suggerimenti di utilizzo degli adattatori KMH (VDI) a pagina 16–19!

Ersatzteile / Spare Parts / Ricambi

Trägerwerkzeug / Holder / Utensile	Schraube / Screw / Vite	Drehmoment / Torque / Coppia	Schlüssel / Key / Chiave
HTE-...-14...	AS 0005	2,5 Nm	T5210-IP

HTE-...-IK2-S...G

Monoblockhalter mit Innenkühlung IK2 von der gegenüberliegenden Seite der Schneide / Monoblock holder with through tool coolant (IK2) access from the opposite side of the cutting edge / Utensile monoblocco con adduzione interna IK2 laterale dal lato opposto all'inserto

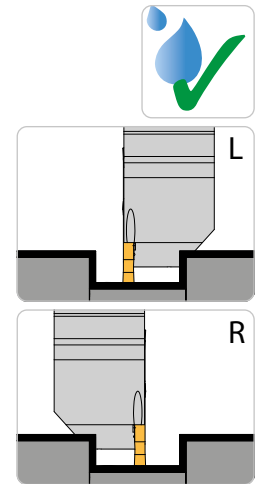
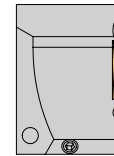
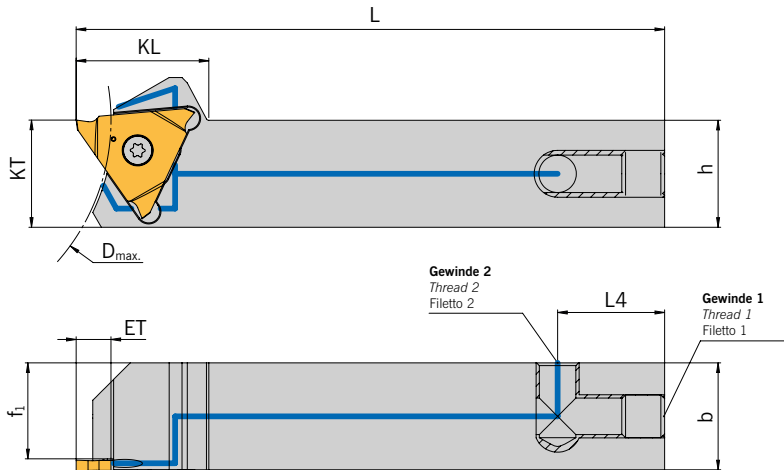

Rechte Ausführung abgebildet
Right-hand execution shown
Versione destra in figura

Trägerwerkzeuge / Holders / Utensili

Ausführung S1G = Gewinde 1: M8x1, Gewinde 2: M8x1 / Execution S1G = Thread 1 M8x1, Thread 2 M8x1 / Esecuzione S1G = filetto 1 M8x1, filetto 2 M8x1

Bezeichnung Designation Articolo	ET	D _{max}	h	b	L	f ₁	KL	KT	L ₄	Gewinde 1 Thread 1 Filetto 1	Gewinde 2 Thread 2 Filetto 2	Größe Size Ampiezza	Schneideinsatz Insert Inserto
HTE-1212L/R-14F-IK2-S1G	6,5	80	12	12	110	9,95	25	20	20	M8x1	M8x1	F	T...14F-...
HTE-1212L/R-14H-IK2-S1G	6,5	80	12	12	110	8,95	25	20	20	M8x1	M8x1	H	T...14H-...
HTE-1212L/R-14K-IK2-S1G	6,5	80	12	12	110	7,95	25	20	20	M8x1	M8x1	K	T...14K-...
HTE-1616L/R-14F-IK2-S1G	6,5	80	16	16	110	13,95	25	20	20	M8x1	M8x1	F	T...14F-...
HTE-1616L/R-14H-IK2-S1G	6,5	80	16	16	110	12,95	25	20	20	M8x1	M8x1	H	T...14H-...
HTE-1616L/R-14K-IK2-S1G	6,5	80	16	16	110	11,95	25	20	20	M8x1	M8x1	K	T...14K-...
HTE-2020L/R-14F-IK2-S1G	6,5	80	20	20	110	17,95	25	± h	20	M8x1	M8x1	F	T...14F-...
HTE-2020L/R-14H-IK2-S1G	6,5	80	20	20	110	16,95	25	± h	20	M8x1	M8x1	H	T...14H-...
HTE-2020L/R-14K-IK2-S1G	6,5	80	20	20	110	15,95	25	± h	20	M8x1	M8x1	K	T...14K-...
HTE-2525L/R-14F-IK2-S1G	6,5	150	25	25	110	22,95	25	± h	20	M8x1	M8x1	F	T...14F-...
HTE-2525L/R-14H-IK2-S1G	6,5	150	25	25	110	21,95	25	± h	20	M8x1	M8x1	H	T...14H-...
HTE-2525L/R-14K-IK2-S1G	6,5	150	25	25	110	20,95	25	± h	20	M8x1	M8x1	K	T...14K-...
HTE-2525L/R-14P-IK2-S1G	6,5	150	25	25	110	19,95	25	± h	20	M8x1	M8x1	P	T...14P-...
HTE-2525L/R-14S-IK2-S1G	6,5	150	25	25	110	18,95	25	± h	20	M8x1	M8x1	S	T...14S-...

Ausführung S2G = Gewinde 1: M8x1, Gewinde 2: G1/8" / Execution S2G = Thread 1: M8x1, Thread 2: G1/8" /
Esecuzione S2G = filetto 1: M8x1, filetto 2: G1/8"

Bezeichnung Designation Articolo	ET	D _{max}	h	b	L	f ₁	KL	KT	L ₄	Gewinde 1 Thread 1 Filetto 1	Gewinde 2 Thread 2 Filetto 2	Größe Size Ampiezza	Schneideinsatz Insert Inserto
HTE-1212L/R-14F-IK2-S2G	6,5	80	12	12	110	9,95	25	20	20	M8x1	G1/8"	F	T...14F-...
HTE-1212L/R-14H-IK2-S2G	6,5	80	12	12	110	8,95	25	20	20	M8x1	G1/8"	H	T...14H-...
HTE-1212L/R-14K-IK2-S2G	6,5	80	12	12	110	7,95	25	20	20	M8x1	G1/8"	K	T...14K-...
HTE-1616L/R-14F-IK2-S2G	6,5	80	16	16	110	13,95	25	20	20	M8x1	G1/8"	F	T...14F-...
HTE-1616L/R-14H-IK2-S2G	6,5	80	16	16	110	12,95	25	20	20	M8x1	G1/8"	H	T...14H-...
HTE-1616L/R-14K-IK2-S2G	6,5	80	16	16	110	11,95	25	20	20	M8x1	G1/8"	K	T...14K-...
HTE-2020L/R-14F-IK2-S2G	6,5	80	20	20	110	17,95	25	± h	20	M8x1	G1/8"	F	T...14F-...
HTE-2020L/R-14H-IK2-S2G	6,5	80	20	20	110	16,95	25	± h	20	M8x1	G1/8"	H	T...14H-...
HTE-2020L/R-14K-IK2-S2G	6,5	80	20	20	110	15,95	25	± h	20	M8x1	G1/8"	K	T...14K-...
HTE-2525L/R-14F-IK2-S2G	6,5	150	25	25	110	22,95	25	± h	20	M8x1	G1/8"	F	T...14F-...
HTE-2525L/R-14H-IK2-S2G	6,5	150	25	25	110	21,95	25	± h	20	M8x1	G1/8"	H	T...14H-...
HTE-2525L/R-14K-IK2-S2G	6,5	150	25	25	110	20,95	25	± h	20	M8x1	G1/8"	K	T...14K-...
HTE-2525L/R-14P-IK2-S2G	6,5	150	25	25	110	19,95	25	± h	20	M8x1	G1/8"	P	T...14P-...
HTE-2525L/R-14S-IK2-S2G	6,5	150	25	25	110	18,95	25	± h	20	M8x1	G1/8"	S	T...14S-...

ARNO® SpecialDesign

Diese Monoblockhalter bekommen Sie mit Ihren spezifischen Kühlschlüssen. Ein Anfrageblatt hierzu finden Sie auf Seite 21 oder im Internet unter: www.arno.de/service/downloads
Bitte beachten Sie den Hinweis zur Verwendung des Halters auf KMH-Werkzeugaufnahme (VDI) auf den Seiten 16–19!

The coolant inlet can be supplied to your specification, please complete enquiry sheet on page 21 or download this from: www.arno.de/service/downloads.

Please refer to notes for using KMH tool holder (VDI) on page 16–19!

Per altre richieste compilare modulo a pag. 21 o scaricarlo da: www.arno.de/service/downloads. Vedere i suggerimenti di utilizzo degli adattatori KMH (VDI) a pagina 16–19!

Ersatzteile / Spare Parts / Ricambi

Trägerwerkzeug / Holder / Utensile	Schraube / Screw / Vite	Drehmoment / Torque / Coppia	Schlüssel / Key / Chiave
HTE-...-14...	AS 0005	2,5 Nm	T5210-IP

HTE-...

Monoblockhalter ohne Innenkühlung

Monoblock holder without through tool coolant
Utensile monoblocco senza adduzione interna

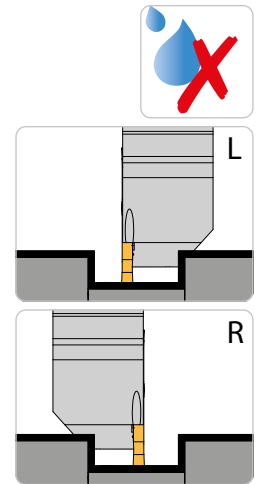
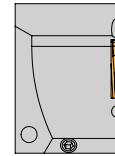
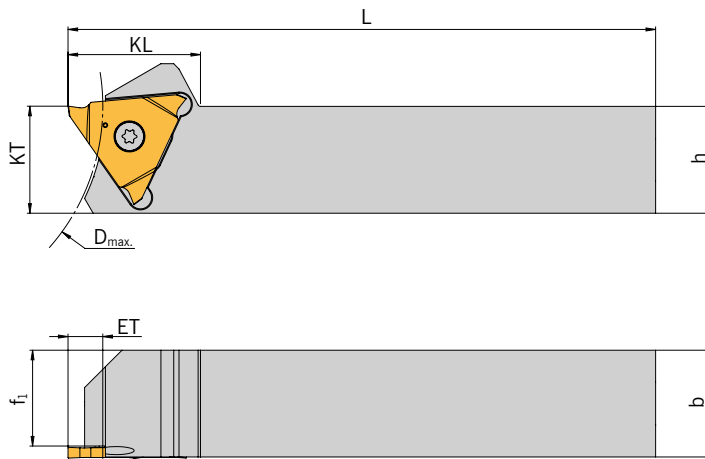

Rechte Ausführung abgebildet
Right-hand execution shown
Versione destra in figura



Trägerwerkzeuge / Holders / Utensili

Bezeichnung Designation Articolo	ET _{max.}	D _{max.}	h	b	L	f ₁	KL	KT	Größe Size Ampiezza	Schneid- einsatz Insert Inserto
HTE-1212L/R-14F	6,5	80	12	12	110	9,95	25	20	F	T...14F-...
HTE-1212L/R-14H	6,5	80	12	12	110	8,95	25	20	H	T...14H-...
HTE-1212L/R-14K	6,5	80	12	12	110	7,95	25	20	K	T...14K-...
HTE-1616L/R-14F	6,5	80	16	16	110	13,95	25	20	F	T...14F-...
HTE-1616L/R-14H	6,5	80	16	16	110	12,95	25	20	H	T...14H-...
HTE-1616L/R-14K	6,5	80	16	16	110	11,95	25	20	K	T...14K-...
HTE-2020L/R-14F	6,5	80	20	20	110	17,95	25	±h	F	T...14F-...
HTE-2020L/R-14H	6,5	80	20	20	110	16,95	25	±h	H	T...14H-...
HTE-2020L/R-14K	6,5	80	20	20	110	15,95	25	±h	K	T...14K-...
HTE-2525L/R-14F	6,5	150	25	25	110	22,95	25	±h	F	T...14F-...
HTE-2525L/R-14H	6,5	150	25	25	110	21,95	25	±h	H	T...14H-...
HTE-2525L/R-14K	6,5	150	25	25	110	20,95	25	±h	K	T...14K-...
HTE-2525L/R-14P	6,5	150	25	25	110	19,95	25	±h	P	T...14P-...
HTE-2525L/R-14S	6,5	150	25	25	110	18,95	25	±h	S	T...14S-...

Ersatzteile / Spare Parts / Ricambi

Trägerwerkzeug / Holder / Utensile	Schraube / Screw / Vite	Drehmoment / Torque / Coppia	Schlüssel / Key / Chiave
HTE-...-14...	AS 0005	2,5 Nm	T5210-IP

HTE-...-IK2-UN

Monoblockhalter mit Innenkühlung IK2 von unten (Nut)

Monoblock holder with coolant supply IK2 from the bottom (Notch)

Utensili monoblocco con refrigerazione interna IK2 da sotto (Asola)

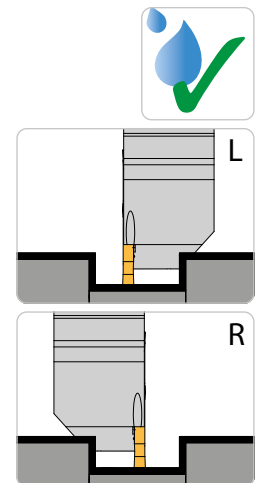
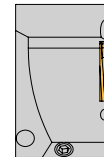
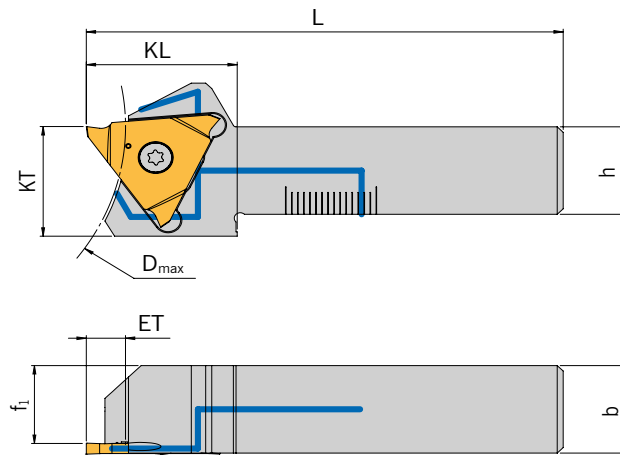

Rechte Ausführung abgebildet
Right-hand execution shown
Versione destra in figura

Trägerwerkzeuge / Holders / Utensili

Bezeichnung Designation Articolo	ET	D _{max}	h	b	L	f ₁	KL	KT	Größe Size Ampiezza	Schneideinsatz Insert Inserto
HTE-1616L/R-14F- IK2-UN	6,5	80	16	16	79	13,95	25	20	F	T...14F-...
HTE-1616L/R-14H- IK2-UN	6,5	80	16	16	79	12,95	25	20	H	T...14H-...
HTE-1616L/R-14K- IK2-UN	6,5	80	16	16	79	11,95	25	20	K	T...14K-...
HTE-2020L/R-14F- IK2-UN	6,5	80	20	20	84,5	17,95	25	± h	F	T...14F-...
HTE-2020L/R-14H- IK2-UN	6,5	80	20	20	84,5	16,95	25	± h	H	T...14H-...
HTE-2020L/R-14K- IK2-UN	6,5	80	20	20	84,5	15,95	25	± h	K	T...14K-...
HTE-2525L/R-14F- IK2-UN	6,5	150	25	25	97	22,95	25	± h	F	T...14F-...
HTE-2525L/R-14H- IK2-UN	6,5	150	25	25	97	21,95	25	± h	H	T...14H-...
HTE-2525L/R-14K- IK2-UN	6,5	150	25	25	97	20,95	25	± h	K	T...14K-...
HTE-2525L/R-14P- IK2-UN	6,5	150	25	25	97	19,95	25	± h	P	T...14P-...
HTE-2525L/R-14S- IK2-UN	6,5	150	25	25	97	18,95	25	± h	S	T...14S-...

ARNO® SpecialDesign

Diese Monoblockhalter bekommen Sie mit Ihren spezifischen Kühlan schlüssen. Ein Anfrageblatt hierzu finden Sie auf Seite 21 oder im Internet unter: www.arno.de/service/downloads
Bitte beachten Sie den Hinweis zur Verwendung des Halters auf KMH-Werkzeugaufnahme (VDI) auf den Seiten 16–19!

The coolant inlet can be supplied to your specification, please complete enquiry sheet on page 21 or download this from: www.arno.de/service/downloads.

Please refer to notes for using KMH tool holder (VDI) on page 16–19!

Per altre richieste compilare modulo a pag. 21 o scaricarlo da: www.arno.de/service/downloads. Vedere i suggerimenti di utilizzo degli adattatori KMH (VDI) a pagina 16–19!

Ersatzteile / Spare Parts / Ricambi

Trägerwerkzeug Holder Utensile	Schraube Screw Vite	Drehmoment Torque Coppia	Schlüssel Key Chiave
HTE-...-14...	AS 0005	2,5 Nm	T5210-IP

Monoblock holders with KMH-holder (VDI)
 Adattatore KMH (VDI) per utensili monoblocco

ATS Monoblockhalter -UN auf KMH-Werkzeugaufnahme - Form B

ATS Monoblock holder -UN with KMH-holder – Form B

ATS Utensili monoblocco -UN con adattatore KMH – Forma B

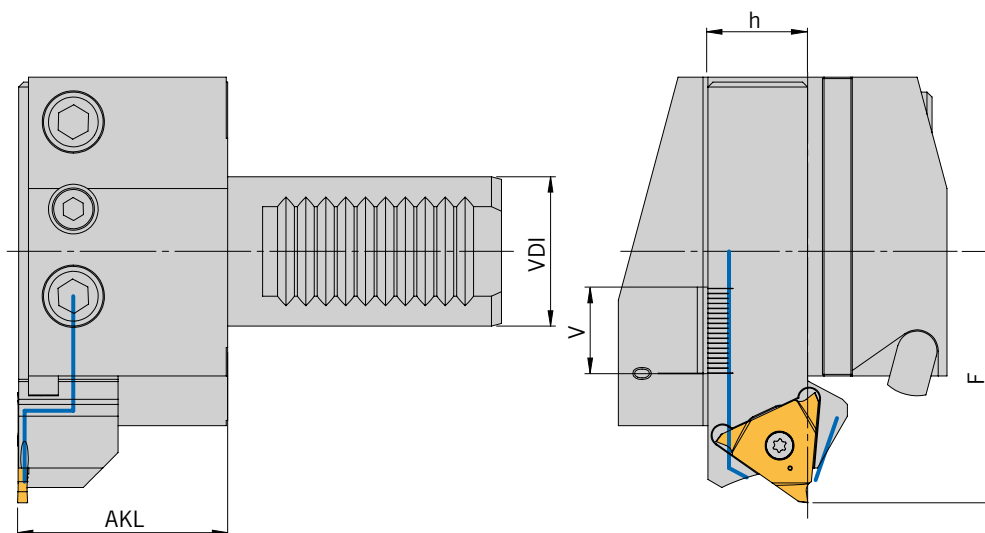

HANDLING:

In Tabelle 1 den benötigten KMH-Werkzeughalter (VDI) und den Halter-Typ auswählen.
 Entsprechend dem Halter-Typ den benötigten Halter und die Schneidplatte mit Tabelle 2 bestimmen.

HANDLING:

Please select the KMH holder (VDI) and holder type from table 1.
 According to holder type please select suitable holder and insert from table 2.

GUIDA ALLA LETTURA:

Scegliere l'adattatore KMH (VDI) e tipologia di forma dalla tabella 1. Dalla tabella 2 scegliere il relativo utensile ed inserto.

KMH-Werkzeugaufnahmen mit KMD und IK-Form B...

KMH holder with coolant jet and through tool coolant – form B...

Adattatore tipo KMH con ugello (KMD) ed lubrificazione interna (IK) – Versiona B...

Typ Type Tipo	VDI	h	AKL	V*	Bezeichnung Designation Articolo	Monoblockhalter Monoblock holder Utensili monoblocco
B1	20	16	32,2	15	KMH01-B1-20x16x30- IK	HTE-1616L-...
	25	16	32,2	15	KMH01-B1-25x16x30- IK	HTE-1616L-...
	30	20	42,2	17	KMH01-B1-30x20x40- IK	HTE-2020L-...
	40	25	47,2	22	KMH01-B1-40x25x44- IK	HTE-2525L-...
B2	25	16	32,2	15	KMH01-B2-25x16x30- IK	HTE-1616R-...
	30	20	42,2	17	KMH01-B2-30x20x40- IK	HTE-2020R-...
	40	25	47,2	22	KMH01-B2-40x25x44- IK	HTE-2525R-...
B3	25	16	32,2	15	KMH01-B3-25x16x30- IK	HTE-1616R-...
	30	20	42,2	17	KMH01-B3-30x20x40- IK	HTE-2020R-...
	40	25	47,2	22	KMH01-B3-40x25x44- IK	HTE-2525R-...
B4	25	16	32,2	15	KMH01-B4-25x16x30- IK	HTE-1616L-...
	30	20	42,2	17	KMH01-B4-30x20x40- IK	HTE-2020L-...
	40	25	47,2	22	KMH01-B4-40x25x44- IK	HTE-2525L-...

* Der Halter kann um den Wert „V“ in der VDI-Aufnahme nach vorne geschoben werden. Die Kühlmittelversorgung ist innerhalb der Skala sichergestellt. Das „F-Maß“ ändert sich entsprechend.

* The holder be adjusted forward bei the „V“ value. The coolant flow is guaranteed according to the adjustment range. The „F“ dimension changes accordingly.

* L'utensile può essere estratto del valore „V“. Il passaggio del refrigerante viene garantito all'interno del campo di registrazione. La dimensione „F“ cambia di conseguenza.

Monoblock holders with KMH-holder (VDI)
Adattatore KMH (VDI) per utensili monoblocco

ATS Monoblockhalter mit Innenkühlung – Übergabe von unten (Nut)

ATS Monoblock holders with through tool coolant – with coolant supply from the bottom (Notch)

ATS Utensili monoblocco con refrigerazione interna - trasferimento dal basso (Asola)





Monoblockhalter Monoblock holder Utensili monoblocco	EB	ET	D _{max}	Bezeichnung Designation Articolo	F	h	Schneideinsatz Insert Inserto
HTE-1616L-...	≤ 2	≤ 6,5	80	HTE-1616L-14F-IK2-UN	55	16	T...14F-...
	2,5 - 3,0	≤ 6,5	80	HTE-1616L-14H-IK2-UN	55		T...14H-...
	4,0	≤ 6,5	80	HTE-1616L-14K-IK2-UN	55		T...14K-...
HTE-1616R-...	≤ 2	≤ 6,5	80	HTE-1616R-14F-IK2-UN	55	16	T...14F-...
	2,5 - 3,0	≤ 6,5	80	HTE-1616R-14H-IK2-UN	55		T...14H-...
	4,0	≤ 6,5	80	HTE-1616R-14K-IK2-UN	55		T...14K-...
HTE-2020L-...	≤ 2	≤ 6,5	80	HTE-2020L-14F-IK2-UN	50,5	20	T...14F-...
	2,5 - 3,0	≤ 6,5	80	HTE-2020L-14H-IK2-UN	50,5		T...14H-...
	4,0	≤ 6,5	80	HTE-2020L-14K-IK2-UN	50,5		T...14K-...
HTE-2020R-...	≤ 2	≤ 6,5	80	HTE-2020R-14F-IK2-UN	50,5	20	T...14F-...
	2,5 - 3,0	≤ 6,5	80	HTE-2020R-14H-IK2-UN	50,5		T...14H-...
	4,0	≤ 6,5	80	HTE-2020R-14K-IK2-UN	50,5		T...14K-...
HTE-2525L-...	≤ 2	≤ 6,5	150	HTE-2525L-14F-IK2-UN	55,5	25	T...14F-...
	2,5 - 3,0	≤ 6,5	150	HTE-2525L-14H-IK2-UN	55,5		T...14H-...
	4,0	≤ 6,5	150	HTE-2525L-14K-IK2-UN	55,5		T...14K-...
	5,0	≤ 6,5	150	HTE-2525L-14P-IK2-UN	55,5		T...14P-...
	6,0	≤ 6,5	150	HTE-2525L-14S-IK2-UN	55,5		T...14S-...
HTE-2525R-...	≤ 2	≤ 6,5	150	HTE-2525R-14F-IK2-UN	55,5	25	T...14F-...
	2,5 - 3,0	≤ 6,5	150	HTE-2525R-14H-IK2-UN	55,5		T...14H-...
	4,0	≤ 6,5	150	HTE-2525R-14K-IK2-UN	55,5		T...14K-...
	5,0	≤ 6,5	150	HTE-2525R-14P-IK2-UN	55,5		T...14P-...
	6,0	≤ 6,5	150	HTE-2525R-14S-IK2-UN	55,5		T...14S-...

Tabelle 2 / Table 2 / Tabella 2

Ersatzteile / Spare Parts / Ricambi

Trägerwerkzeug Holder Utensile	Schraube Screw Vite	Drehmoment Torque Coppia	Schlüssel Key Chiave
HTE-...-14...	AS 0005	2,5 Nm	T5210-IP

Einbaumöglichkeiten / Assembly options / Combinazioni di montaggio

Aufnahme KMH01-B...-IK mit linkem Monoblockhalter Holder KMH01-B...-IK with left monoblock holder Adattatore KMH01-B...-IK con utensile monoblocco sinistro		Aufnahme KMH01-B...-IK mit rechtem Monoblockhalter Holder KMH01-B...-IK with right monoblock holder Adattatore KMH01-B...-IK con utensile monoblocco destro	
KMH01-B1-...-IK	KMH01-B4-...-IK	KMH01-B2-...-IK	KMH01-B3-...-IK
			
Einbaulage normal Normal assembly Montaggio normale	Einbaulage Überkopf Upside down assembly Montaggio invertito	Einbaulage normal Normal assembly Montaggio normale	Einbaulage Überkopf Upside down assembly Montaggio invertito

Monoblock holders with KMH-holder (VDI)
 Adattatore KMH (VDI) per utensili monoblocco

ATS Monoblockhalter -UN auf KMH-Werkzeugaufnahme - Form C

ATS Monoblock holder -UN with KMH-holder – Form C

ATS Utensili monoblocco -UN con adattatore KMH – Forma C

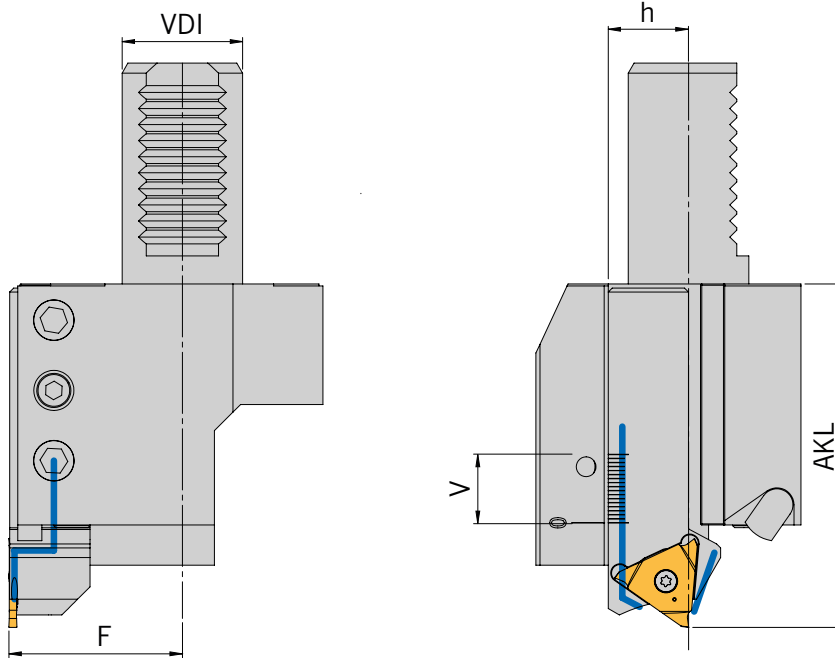

HANDLING: In Tabelle 1 den benötigten KMH-Werkzeughalter (VDI) und den Halter-Typ auswählen. Entsprechend dem Halter-Typ den benötigten Halter und die Schneidplatte mit Tabelle 2 bestimmen.

HANDLING: Please select the KMH holder (VDI) and holder type from table 1. According to holder type please select suitable holder and insert from table 2.

GUIDA ALLA LETTURA: Scegliere l'adattatore KMH (VDI) e tipologia di forma dalla tabella 1. Dalla tabella 2 scegliere il relativo utensile ed inserto.

KMH-Werkzeugaufnahmen mit KMD und IK-Form C...

KMH holder with coolant jet and through tool coolant – form C...

Adattatore tipo KMH con ugello (KMD) ed lubrificazione interna (IK) – Versiona C...

Typ Type Tipo	VDI	h	F	V*	Bezeichnung Designation Articolo	Monoblockhalter Monoblock holder Utensili monoblocco
C1	25	16	35,2	15	KMH01-C1-25x16x55- IK	HTE-1616R-...
	30	20	37,2	17	KMH01-C1-30x20x70- IK	HTE-2020R-...
	40	25	46,2	22	KMH01-C1-40x25x85- IK	HTE-2525R-...
C2	25	16	35,2	15	KMH01-C2-25x16x55- IK	HTE-1616L-...
	30	20	43,2	17	KMH01-C2-30x20x70- IK	HTE-2020L-...
	40	25	50,7	22	KMH01-C2-40x25x85- IK	HTE-2525L-...
C3	25	16	35,2	15	KMH01-C3-25x16x55- IK	HTE-1616L-...
	30	20	37,2	17	KMH01-C3-30x20x70- IK	HTE-2020L-...
	40	25	46,2	22	KMH01-C3-40x25x85- IK	HTE-2525L-...
C4	25	16	35,2	15	KMH01-C4-25x16x55- IK	HTE-1616R-...
	25	20	39,2	17	KMH01-C4-25x20x70- IK	HTE-2020R-...
	30	20	43,2	17	KMH01-C4-30x20x70- IK	HTE-2020R-...
	40	25	50,7	22	KMH01-C4-40x25x85- IK	HTE-2525R-...

* Der Halter kann um den Wert „V“ in der VDI-Aufnahme nach vorne geschoben werden. Die Kühlmittelversorgung ist innerhalb der Skala sichergestellt. Das „AKL-Maß“ ändert sich entsprechend.
 * The holder be adjusted forward by the „V“ value. The coolant flow is guaranteed according to the adjustment range. The „AKL“ dimension changes accordingly.
 * L'utensile può essere estratto del valore „V“. Il passaggio del refrigerante viene garantito all'interno del campo di registrazione. La dimensione "AKL" cambia di conseguenza.

Monoblock holders with KMH-holder (VDI)
 Adattatore KMH (VDI) per utensili monoblocco

ATS Monoblockhalter mit Innenkühlung – Übergabe von unten (Nut)

ATS Monoblock holders with through tool coolant – with coolant supply from the bottom (Notch)

ATS Utensili monoblocco con refrigerazione interna - trasferimento dal basso (Asola)





Monoblockhalter Monoblock holder Utensili monoblocco	EB	ET	D _{max}	Bezeichnung Designation Articolo	AKL	h	Schneideinsatz Insert Inserto
HTE-1616L-...	≤ 2,0	≤ 6,5	80	HTE-1616L-14F-IK2-UN	80,0	16	T...14F-...
	2,5 - 3,0	≤ 6,5	80	HTE-1616L-14H-IK2-UN	80,0		T...14H-...
	4,0	≤ 6,5	80	HTE-1616L-14K-IK2-UN	80,0		T...14K-...
HTE-1616R-...	≤ 2,0	≤ 6,5	80	HTE-1616R-14F-IK2-UN	80,0	16	T...14F-...
	2,5 - 3,0	≤ 6,5	80	HTE-1616R-14H-IK2-UN	80,0		T...14H-...
	4,0	≤ 6,5	80	HTE-1616R-14K-IK2-UN	80,0		T...14K-...
HTE-2020L-...	≤ 2,0	≤ 6,5	80	HTE-2020L-14F-IK2-UN	85,5	20	T...14F-...
	2,5 - 3,0	≤ 6,5	80	HTE-2020L-14H-IK2-UN	85,5		T...14H-...
	4,0	≤ 6,5	80	HTE-2020L-14K-IK2-UN	85,5		T...14K-...
HTE-2020R-...	≤ 2,0	≤ 6,5	80	HTE-2020R-14F-IK2-UN	85,5	20	T...14F-...
	2,5 - 3,0	≤ 6,5	80	HTE-2020R-14H-IK2-UN	85,5		T...14H-...
	4,0	≤ 6,5	80	HTE-2020R-14K-IK2-UN	85,5		T...14K-...
HTE-2525L-...	≤ 2,0	≤ 6,5	150	HTE-2525L-14F-IK2-UN	98,0	25	T...14F-...
	2,5 - 3,0	≤ 6,5	150	HTE-2525L-14H-IK2-UN	98,0		T...14H-...
	4,0	≤ 6,5	150	HTE-2525L-14K-IK2-UN	98,0		T...14K-...
	5,0	≤ 6,5	150	HTE-2525L-14P-IK2-UN	98,0		T...14P-...
	6,0	≤ 6,5	150	HTE-2525L-14S-IK2-UN	98,0		T...14S-...
HTE-2525R-...	≤ 2,0	≤ 6,5	150	HTE-2525R-14F-IK2-UN	98,0	25	T...14F-...
	2,5 - 3,0	≤ 6,5	150	HTE-2525R-14H-IK2-UN	98,0		T...14H-...
	4,0	≤ 6,5	150	HTE-2525R-14K-IK2-UN	98,0		T...14K-...
	5,0	≤ 6,5	150	HTE-2525R-14P-IK2-UN	98,0		T...14P-...
	6,0	≤ 6,5	150	HTE-2525R-14S-IK2-UN	98,0		T...14S-...

Tabelle 2 / Table 2 / Tabella 2

Ersatzteile / Spare Parts / Ricambi

Trägerwerkzeug Holder Utensile	Schraube Screw Vite	Drehmoment Torque Coppia	Schlüssel Key Chiave
HTE-...-14...	AS 0005	2,5 Nm	T5210-IP

Einbaumöglichkeiten / Assembly options / Combinazioni di montaggio

Aufnahme KMH01-C...-IK mit linkem Monoblockhalter Holder KMH01-C...-IK with left monoblock holder Adattatore KMH01-C...-IK con utensile monoblocco sinistro		Aufnahme KMH01-C...-IK mit rechtem Monoblockhalter Holder KMH01-C...-IK with right monoblock holder Adattatore KMH01-C...-IK con utensile monoblocco destro	
KMH01-C2-...-IK	KMH01-C3-...-IK	KMH01-C1-...-IK	KMH01-C4-...-IK
			
Einbaulage normal Normal assembly Montaggio normale	Einbaulage Überkopf Upside down assembly Montaggio invertito	Einbaulage normal Normal assembly Montaggio normale	Einbaulage Überkopf Upside down assembly Montaggio invertito

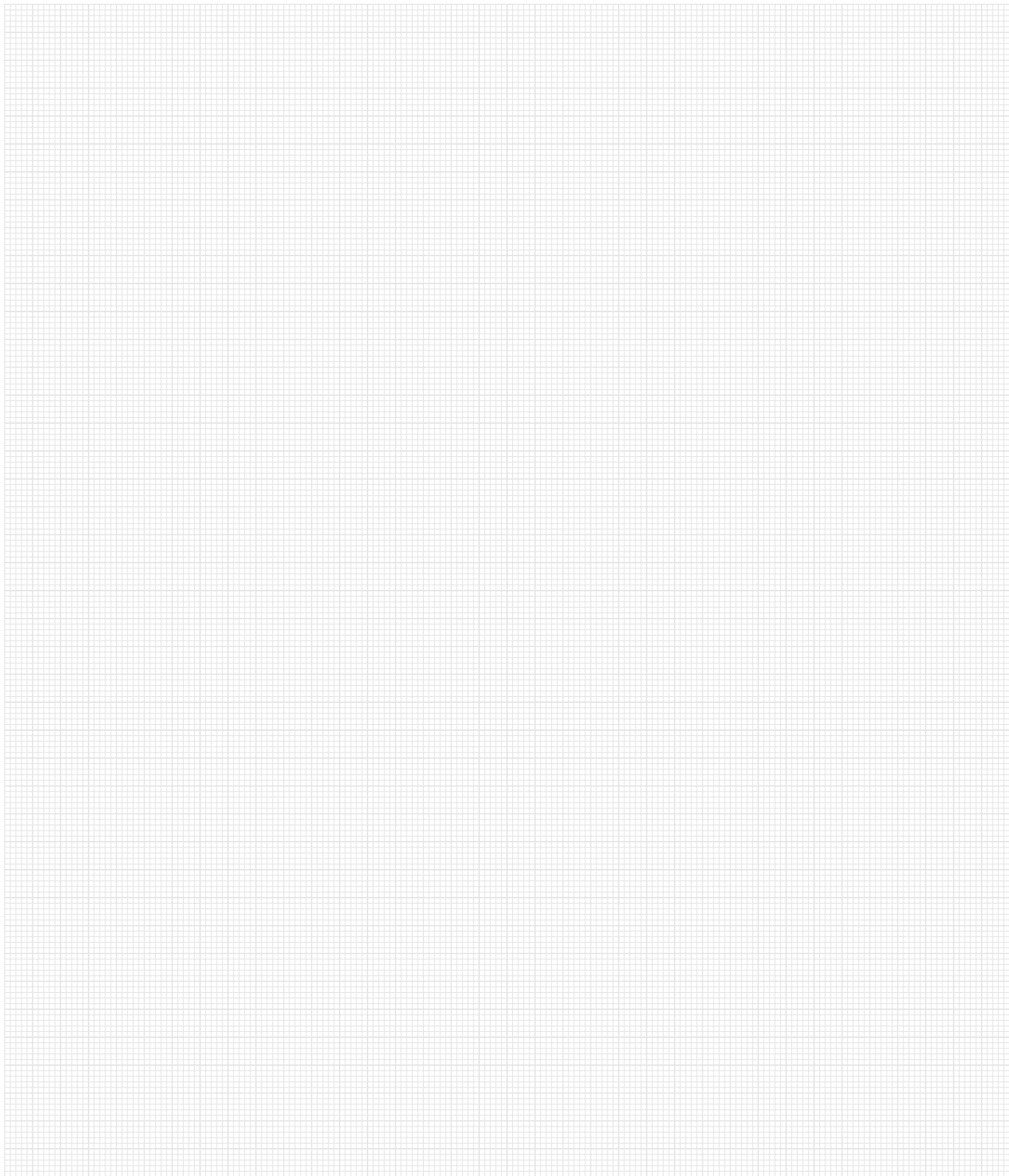

Weitere Informationen finden Sie unter
For more information see
Per maggiori informazioni visita il sito

www.arno.de

Enquiry holder ATS with special dimensions
 Richiesta utensili ATS con dimensioni speciali



Monoblockhalter mit Innenkühlung IK2 von hinten

Monoblock holder with through tool coolant access from the back
 Utensile monoblocco con adduzione interna IK2 posteriore

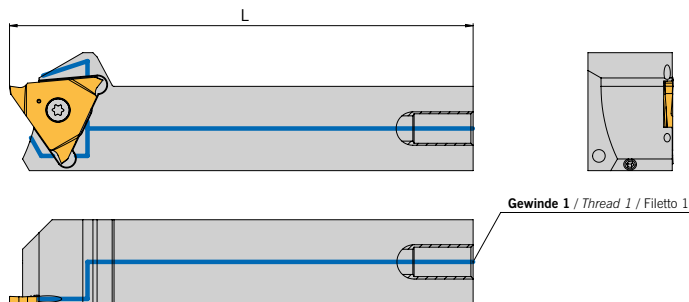

Aus Halter
From holder
Da utensile

Gewinde 1
Thread 1
Filetto 1

L



Diese Halter fertigen wir Ihnen zum Preis des Standardwerkzeuges.
 This tool we produce to the price of the standard tool.
 Questi utensili vengono realizzati al prezzo dello standard.

Monoblockhalter mit Innenkühlung IK2 von der Seite

Monoblock holder with through tool coolant access from the side
 Utensile monoblocco con adduzione interna IK2 laterale

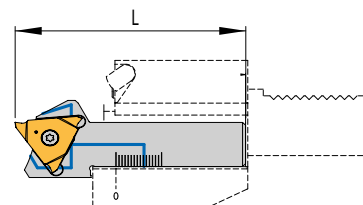
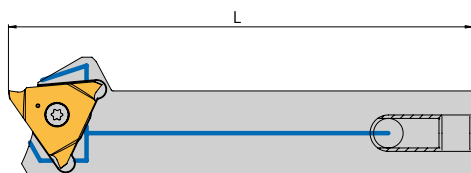

Ausführung S. – Das Gewinde 2 ist auf der gleichen Seite wie die Schneide

Design S. – Thread 2 is on the same side as the cutting edge
 Versione S. – Filetto 2 sul medesimo lato dell'inserto

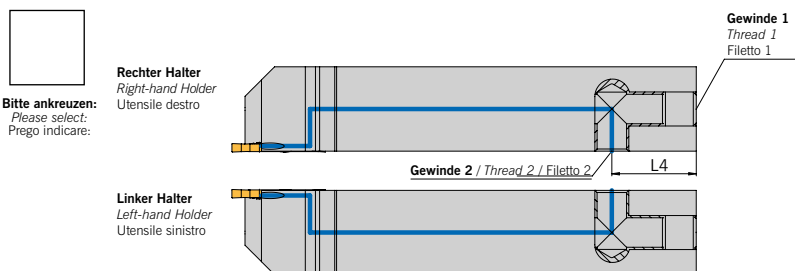

Bitte ankreuzen:
Please select:
Prego indicare:

Rechter Halter
Right-hand Holder
Utensile destro

Linker Halter
Left-hand Holder
Utensile sinistro

Ausführung SG. – Das Gewinde 2 ist gegenüber der Schneide

Design SG. – Thread 2 is on the opposite side of the cutting edge
 Versione SG. – Filetto 2 sul lato opposto l'inserto

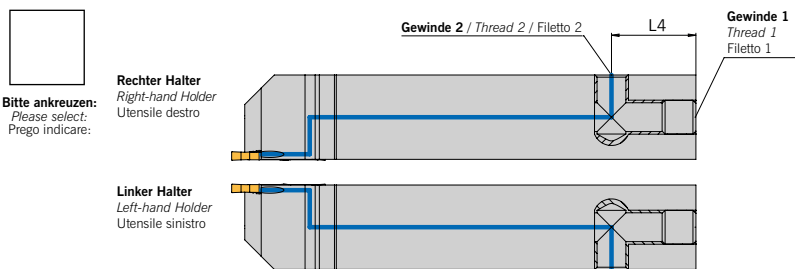

Bitte ankreuzen:
Please select:
Prego indicare:

Rechter Halter
Right-hand Holder
Utensile destro

Linker Halter
Left-hand Holder
Utensile sinistro

Aus Halter
From holder
Da utensile

Gewinde 1
Thread 1
Filetto 1

Gewinde 2
Thread 2
Filetto 2

L₄

L

Hinweis bei Verwendung auf KMH-Werkzeugaufnahme (VDI) Form C

Remark by using the KMH holders (VDI) Form C

Nota sull'utilizzo adattatori KMH (VDI) Forma C

Beim Einsatz der Halter in VDI-Aufnahmen Form C bitte die Gesamtlänge (L) nach folgender Maximallänge festlegen:

When using VDI holders Form C, please set overall length (L) by following maximum lengths:

Con l'utilizzo di adattatori VDI forma C impostare la lunghezza totale (L) secondo la seguente tabella:

Bezeichnung Designation Articolo	L
HTE-1616L/R-14F-IK2...	80,0
HTE-1616L/R-14H-IK2...	
HTE-1616L/R-14K-IK2...	
HTE-2020L/R-14F-IK2...	85,5
HTE-2020L/R-14H-IK2...	
HTE-2020L/R-14K-IK2...	
HTE-2525L/R-14F-IK2...	98,0
HTE-2525L/R-14H-IK2...	
HTE-2525L/R-14K-IK2...	
HTE-2525L/R-14P-IK2...	
HTE-2525L/R-14S-IK2...	

Lang drehen, schnell Wechseln.

Swiss type machining, fast changes.

Tornitura cilindrica, cambio utensile rapido.

AFC-Trägerwerkzeug: die Revolution für den schnellen Werkzeugwechsel – angemeldet zum Patent.

Ihre Lösung für einen komfortablen Werkzeugwechsel trotz engem Innenraum bei Langdrehmaschinen: Der zweiteilige AFC-Träger, mit dem selbst ungelesenes Personal Werkzeuge schnell und sicher austauschen kann.

So funktioniert´s: Der hintere Teil des Trägerwerkzeugs (AHA-Anschlag) wird einmal fixiert. Für den Austausch des Werkzeugs muss nur das Vorderteil abgenommen werden. Ein erneutes Anfahren und Einstellen des Nullpunkts entfällt durch die immer gleiche Länge zur Spitze des Schneideinsatzes damit komplett – egal, ob er das Drehsystem oder das Stechsystem benutzt. Verbunden werden beide Trägerteile einfach über ein Stecksystem mit O-Ring. Dadurch ist das Vorderteil beim Aufsetzen auf die Steckverbindung sofort gesichert – nichts fällt versehentlich in die Maschine. Gleichzeitig bleibt durch eine schwimmend gelagerte Halterung genug Spielraum für einen Ausgleich des Winkelversatzes, die beiden Teile schmiegen sich optimal aneinander. So profitieren Sie von einer hohen Wechselgenauigkeit und einer dichten Kühlmittelübergabe.

AFC tool holders: the revolution in fast tool changes – patent applied.

Your solution for easy tool changes despite space constraints in Swiss type machines: the two-part AFC holder – even untrained staff can replace tools fast and reliably.

This is how it works: The rear part of the tool holder (AHA fixed stop) is first fixed in place. Only the front part is removed to replace the tool. This eliminates the need to restart and recalibrate the zero point since the length to the insert tip is always the same – whether the grooving system or the turning system is used. The two holder parts are simply joined by a connector system with O-ring. The front part is then secured immediately it is placed in the connector – nothing drops into the machine accidentally. At the same time, the floating mount provides enough clearance to compensate for angle offset. The two parts then fit together perfectly. Now you benefit from a high level of precision when changing tools and a leak-proof coolant hole.

Portautensili AFC: la rivoluzione per il cambio utensile rapido – in attesa di brevetto.

La vostra soluzione per un cambio utensili confortevole nonostante il ridotto spazio interno nei torni a fantina mobile: Il supporto AFC in due parti con il quale anche il personale non addestrato può sostituire gli utensili in modo rapido e sicuro.

Funziona così: la parte posteriore dell'utensile (arresto AHA) viene fissata. Per sostituire l'utensile, deve essere rimossa solo la parte anteriore. Non è necessario un nuovo avviamento e una nuova regolazione del punto zero dal momento che la punta dell'inserto ha sempre la medesima lunghezza, indipendentemente dal fatto che si utilizzi un sistema di tornitura o un sistema di scanalatura. Le due parti del supporto vengono collegate mediante un sistema ad innesto con o-ring. La parte anteriore viene subito assicurata quando viene posizionata sull'innesto a spina – nulla può cadere inavvertitamente all'interno della macchina. Allo stesso tempo, un supporto flottante lascia gioco sufficiente per compensare il disallineamento angolare, le due parti si incastrano in modo ottimale l'una nell'altra. Approfittate anche voi di un'elevata precisione di cambio e di un canale ermetico del refrigerante.

Toleranz Einstechbreite EB ±0,02 mm
Tolerance groove width EB ±0,02 mm
 Larghezza gola tolleranza EB ±0,02 mm

Geometrie -GA mit 8° Spanwinkel
Geometry -GA with 8° rake angle
 Geometria -GA, angolo di spoglia superiore di 8°

Geschliffene Auflagefläche
Ground contact surface
 Superficie di appoggio rettificata



Universelle Hochleistungs-Sorte AP5020
Universal high-performance grade AP5020
 Varietà universale ad alte prestazioni AP5020

Geschliffene Anlageflächen
Ground contact surfaces
 Superfici di appoggio

Einstehtiefe ET max. 6,5 mm
Cutting depths up to ET = 6.5 mm
 Profondità di scanalatura fino a ET = 6,5 mm

Standard: optimale Kühlung der Freifläche
Standard: optimised cooling of the tool flank
 Standard: raffreddamento ottimale del fianco

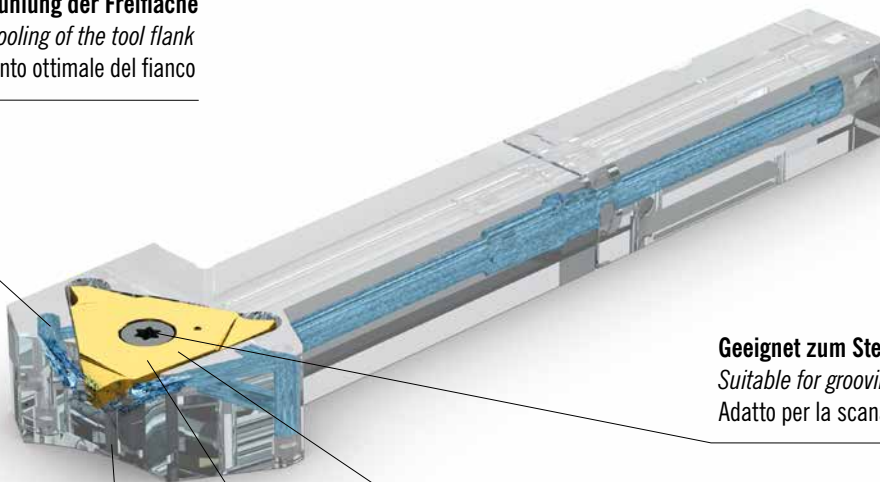

Geeignet zum Stechen an der Schulter
Suitable for grooving at the shoulder
 Adatto per la scanalatura degli spallamenti

Optimale Positioniergenauigkeit durch komplett geschliffene Ausführung
Optimal positioning accuracy due to the completely periphery grinding
 Precisione di posizionamento ottimale grazie al design completamente rettificato

Standard: direkte Kühlung der Spanfläche
Standard: direct cooling of the cutting edge
 Standard: raffreddamento diretto della superficie di spoglia superiore

Stechsystem mit 3-schneidiger T-Wendeschneidplatte
Grooving system with T-shaped indexable insert with 3 cutting edges
 Sistema di scanalatura con inserto a 3 taglianti

Holders with screw clamping for sliding head auto lathes
 Steli con fissaggio a vite per fantina mobile

HTE-...-IK2-AFC

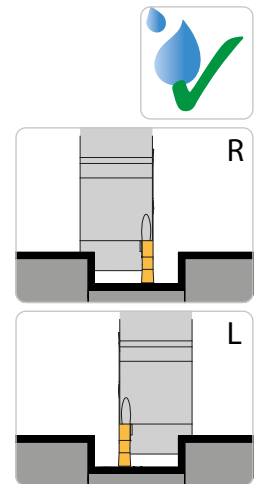
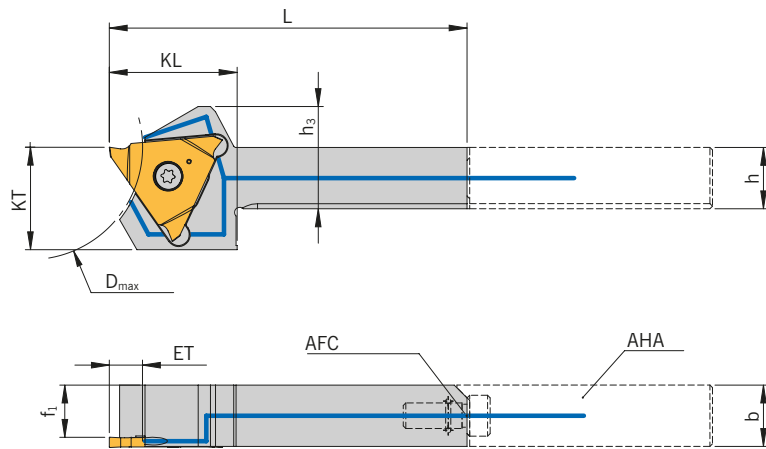

Rechte Ausführung abgebildet
 Right-hand execution shown
 Versione destra in figura

Trägerwerkzeuge / Holders / Utensili

Bezeichnung Designation Articolo	ET _{max}	D _{max}	h	b	h ₃	L	f ₁	KL	KT	Größe Size Ampiezza	Schneid- einsatz Insert Inserto
HTE-1212L/R-14F-IK2-AFC	6,5	44	12	12	20	70	9,95	25	20	F	T...14F-...
HTE-1212L/R-14H-IK2-AFC	6,5	44	12	12	20	70	8,95	25	20	H	T...14H-...
HTE-1212L/R-14K-IK2-AFC	6,5	44	12	12	20	70	7,95	25	20	K	T...14K-...
HTE-1616L/R-14F-IK2-AFC	6,5	44	16	16	24	70	13,95	25	20	F	T...14F-...
HTE-1616L/R-14H-IK2-AFC	6,5	44	16	16	24	70	12,95	25	20	H	T...14H-...
HTE-1616L/R-14K-IK2-AFC	6,5	44	16	16	24	70	11,95	25	20	K	T...14K-...

Ersatzteile / Spare Parts / Ricambi

Trägerwerkzeug Holder Utensile	Schraube Screw Vite	Drehmoment Torque Coppia	Schlüssel Key Chiave	O-Ring O-ring O-ring
HTE-1212L/R-14...-IK2-AFC	AS 0005	2,5 Nm	T5210-IP	OR 4,7X1 FKM80 SCHWARZ
HTE-1616L/R-14...-IK2-AFC	AS 0005	2,5 Nm	T5210-IP	OR 4,7X1,6 NBR70

Geometriebeschreibung / Geometry description / Descrizione delle Geometria

-GA

- **Hervorragend geeignet für die Bearbeitung von Stahl und nichtrostendem Stahl**
- **Komplett geschliffene Geometrie**
- **Hohe Präzision und Wiederholgenauigkeit**
- *Excellent for machining steel and stainless steel*
- *Completely ground geometry*
- *High precision and repeatability*
- *Adatto in maniera eccellente alla lavorazione di acciaio e acciaio inossidabile*
- *Geometria completamente rettificata*
- *Elevata precisione e accuratezza di ripetibilità*

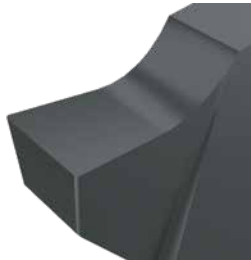

Schlichten <i>Finishing</i> Finitura		Mittlere Bearbeitung <i>Medium machining</i> Medie asportazioni			Schruppen <i>Roughing</i> Sgrossatura	
P	M	K	N	S	H	
●	○	○	○	○		

-GB

- **Sehr weichschneidende Geometrie**
- **Komplett geschliffene Geometrie**
- **Geringe Schnittkräfte**
- *Very soft cutting geometry*
- *Completely ground geometry*
- *Low cutting force*
- *Geometria dal taglio dolce*
- *Geometria completamente rettificata*
- *Ridotta forza di taglio*



Schlichten <i>Finishing</i> Finitura		Mittlere Bearbeitung <i>Medium machining</i> Medie asportazioni			Schruppen <i>Roughing</i> Sgrossatura	
P	M	K	N	S	H	
●	○	○	○	○		

Sortenbeschreibung / Grade description / Descrizione delle Geometria

AP5020

- **Universell einsetzbare Sorte**
- **Gutes Zusammenspiel von Verschleißfestigkeit und Zähigkeit**
- **Hohe Beständigkeit gegen Oxidation**
- *Universally applicable type*
- *Good interplay between wear resistance and toughness*
- *High resistance to oxidation*
- *Varietà utilizzabile universalmente*
- *Buona interazione tra resistenza all'usura e tenacità*
- *Elevata resistenza all'ossidazione*

PVD



Verschleißfestigkeit <i>Wear resistance</i> Resistenza all'usura		10		20		30		40		Zähigkeit <i>Toughness</i> Tenacità
P	M	K	N	S	H					
●	○	○	○	○						

TE14...

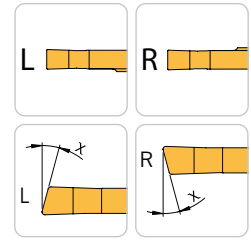
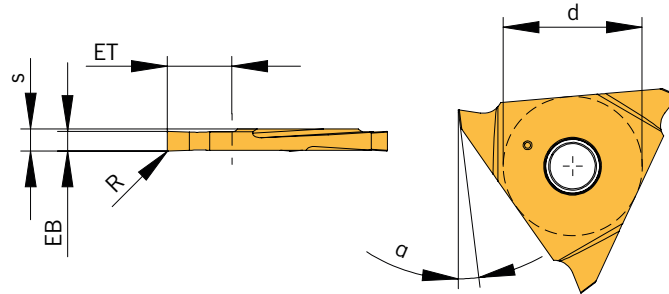

Schneideinsätze Geradmaße / Inserts straight dimensions / Inserti dimensioni diritte

Bezeichnung Designation Articolo	EB ± 0,02	R	ET	d	s	α	χ	Größe Size Ampiezza	HC
									AP5020
TE14F-080-3001ER-GA	0,8	0,1	3,0	14	2,25	7°	0°	F	◆
TE14F-100-3001EL-GA	1,0	0,1	3,0	14	2,25	7°	0°	F	◆
TE14F-100-3001EL-GA-15L	1,0	0,1	3,0	14	2,25	7°	15°	F	◆
TE14F-100-3001ER-GA	1,0	0,1	3,0	14	2,25	7°	0°	F	◆
TE14F-100-6501EL-GA	1,0	0,1	6,5	14	2,25	7°	0°	F	◆
TE14F-100-6501ER-GA	1,0	0,1	6,5	14	2,25	7°	0°	F	◆
TE14F-150-3001EL-GA	1,5	0,1	3,0	14	2,25	7°	0°	F	◆
TE14F-150-3001ER-GA	1,5	0,1	3,0	14	2,25	7°	0°	F	◆
TE14F-150-6501EL-GA	1,5	0,1	6,5	14	2,25	7°	0°	F	◆
TE14F-150-6501ER-GA	1,5	0,1	6,5	14	2,25	7°	0°	F	◆
TE14F-150-6501ER-GA-5R	1,5	0,1	6,5	14	2,25	7°	5°	F	◆
TE14F-200-6501EL-GA	2,0	0,1	6,5	14	2,25	7°	0°	F	◆
TE14F-200-6501ER-GA	2,0	0,1	6,5	14	2,25	7°	0°	F	◆
TE14F-200-6502EL-GA	2,0	0,2	6,5	14	2,25	7°	0°	F	◆
TE14F-200-6502ER-GA	2,0	0,2	6,5	14	2,25	7°	0°	F	◆
TE14F-200-6502ER-GA-15R	2,0	0,2	6,5	14	2,25	7°	15°	F	◆
TE14H-250-6502EL-GA	2,5	0,2	6,5	14	3,25	7°	0°	H	◆
TE14H-250-6502ER-GA	2,5	0,2	6,5	14	3,25	7°	0°	H	◆
TE14H-250-6504EL-GA	2,5	0,4	6,5	14	3,25	7°	0°	H	◆
TE14H-250-6504ER-GA	2,5	0,4	6,5	14	3,25	7°	0°	H	◆
TE14H-300-6502EL-GA	3,0	0,2	6,5	14	3,25	7°	0°	H	◆
TE14H-300-6502ER-GA	3,0	0,2	6,5	14	3,25	7°	0°	H	◆
TE14H-300-6504EL-GA	3,0	0,4	6,5	14	3,25	7°	0°	H	◆
TE14H-300-6504ER-GA	3,0	0,4	6,5	14	3,25	7°	0°	H	◆
TE14K-400-6502EL-GA	4,0	0,2	6,5	14	4,25	7°	0°	K	◆
TE14K-400-6502ER-GA	4,0	0,2	6,5	14	4,25	7°	0°	K	◆
TE14K-400-6504EL-GA	4,0	0,4	6,5	14	4,25	7°	0°	K	◆
TE14K-400-6504ER-GA	4,0	0,4	6,5	14	4,25	7°	0°	K	◆

Bezeichnung Designation Articolo	EB ± 0,02	R	ET	d	s	α	χ	Größe Size Ampiezza	HC
									AP5020
TE14P-500-6502EL-GA	5,0	0,2	6,5	14	5,25	7°	0°	P	◆
TE14P-500-6502ER-GA	5,0	0,2	6,5	14	5,25	7°	0°	P	◆
TE14P-500-6504EL-GA	5,0	0,4	6,5	14	5,25	7°	0°	P	◆
TE14P-500-6504ER-GA	5,0	0,4	6,5	14	5,25	7°	0°	P	◆
TE14S-600-6504EL-GA	6,0	0,4	6,5	14	6,25	7°	0°	S	◆
TE14S-600-6504ER-GA	6,0	0,4	6,5	14	6,25	7°	0°	S	◆

HC = Hartmetall beschichtet / Carbide coated / Metallo duro rivestito

P	●
M	○
K	
N	○
S	○
H	

● Hauptanwendung
Main application
Applicazione principale

○ Nebenanwendung
Secondary application
Applicazione secondaria

TV14...

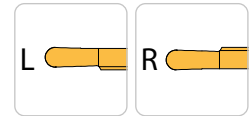
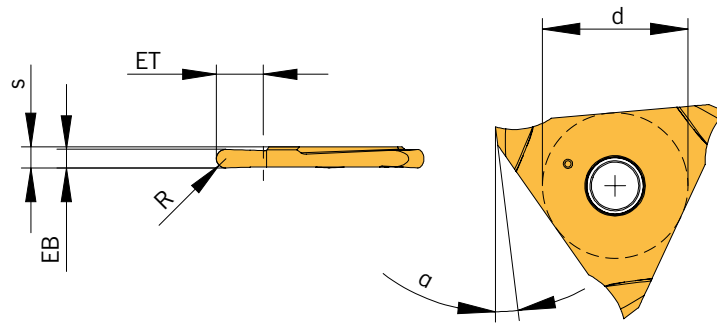

Schneideinsätze Vollradius / Full radius inserts / Inserti per gole a raggio completo

Bezeichnung Designation Articolo	EB ± 0,02	R	ET	d	s	α	Größe Size Ampiezza	HC
								AP5020
TV14F-100-3005EL-GB	1,0	0,5	3,0	14	2,25	7°	F	◆
TV14F-100-3005ER-GB	1,0	0,5	3,0	14	2,25	7°	F	◆
TV14F-200-5010EL-GB	2,0	1,0	5,0	14	2,25	7°	F	◆
TV14F-200-5010ER-GB	2,0	1,0	5,0	14	2,25	7°	F	◆
TV14H-300-5015EL-GB	3,0	1,5	5,0	14	3,25	7°	H	◆
TV14H-300-5015ER-GB	3,0	1,5	5,0	14	3,25	7°	H	◆
TV14K-400-5020EL-GB	4,0	2,0	5,0	14	4,25	7°	K	◆
TV14K-400-5020ER-GB	4,0	2,0	5,0	14	4,25	7°	K	◆

HC = Hartmetall beschichtet / Carbide coated / Metallo duro rivestito

P	●
M	○
K	○
N	○
S	○
H	

● Hauptanwendung
Main application
Applicazione principale

○ Nebenanwendung
Secondary application
Applicazione secondaria

TS14...

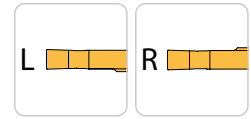
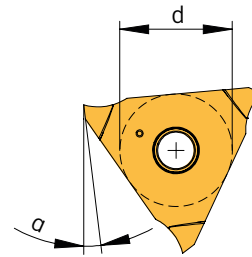
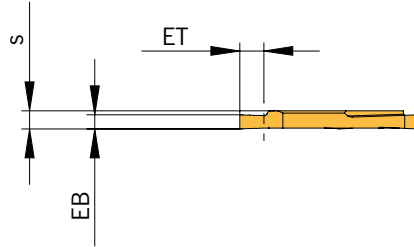

Schneideinsätze für Seegerringnuten DIN 471/472 / Inserts for circlip grooves to DIN 471/472 / Inserti per gole sedi seeger DIN 471/472

Bezeichnung Designation Articolo	EB - 0,05	m* H13	ET	d	s	α	Größe Size Ampiezza	HC
								AP5020
TS14F-050-070EL-GB	0,57	0,50	0,7	14	2,25	7°	F	◆
TS14F-050-070ER-GB	0,57	0,50	0,7	14	2,25	7°	F	◆
TS14F-060-080EL-GB	0,67	0,60	0,8	14	2,25	7°	F	◆
TS14F-060-080ER-GB	0,67	0,60	0,8	14	2,25	7°	F	◆
TS14F-070-110EL-GB	0,77	0,70	1,1	14	2,25	7°	F	◆
TS14F-070-110ER-GB	0,77	0,70	1,1	14	2,25	7°	F	◆
TS14F-080-120EL-GB	0,87	0,80	1,2	14	2,25	7°	F	◆
TS14F-080-120ER-GB	0,87	0,80	1,2	14	2,25	7°	F	◆
TS14F-090-140EL-GB	0,97	0,90	1,4	14	2,25	7°	F	◆
TS14F-090-140ER-GB	0,97	0,90	1,4	14	2,25	7°	F	◆
TS14F-100-160EL-GB	1,07	1,00	1,6	14	2,25	7°	F	◆
TS14F-100-160ER-GB	1,07	1,00	1,6	14	2,25	7°	F	◆
TS14F-110-200EL-GB	1,24	1,10	2,0	14	2,25	7°	F	◆
TS14F-110-200ER-GB	1,24	1,10	2,0	14	2,25	7°	F	◆
TS14F-130-200EL-GB	1,44	1,30	2,0	14	2,25	7°	F	◆
TS14F-130-200ER-GB	1,44	1,30	2,0	14	2,25	7°	F	◆
TS14F-160-300EL-GB	1,74	1,60	3,0	14	2,25	7°	F	◆
TS14F-160-300ER-GB	1,74	1,60	3,0	14	2,25	7°	F	◆
TS14F-185-300EL-GB	1,99	1,85	3,0	14	2,25	7°	F	◆
TS14F-185-300ER-GB	1,99	1,85	3,0	14	2,25	7°	F	◆
TS14H-215-400EL-GB	2,29	2,15	4,0	14	3,25	7°	H	◆
TS14H-215-400ER-GB	2,29	2,15	4,0	14	3,25	7°	H	◆
TS14H-265-400EL-GB	2,79	2,65	4,0	14	3,25	7°	H	◆
TS14H-265-400ER-GB	2,79	2,65	4,0	14	3,25	7°	H	◆
TS14K-315-500EL-GB	3,29	3,15	5,0	14	4,25	7°	K	◆
TS14K-315-500ER-GB	3,29	3,15	5,0	14	4,25	7°	K	◆

HC = Hartmetall beschichtet / Carbide coated / Metallo duro rivestito

* Nutbreite „m“ / Groove width “m” / Larghezza di scanalatura “m”

P	●
M	○
K	○
N	○
S	○
H	○

● Hauptanwendung
Main application
Applicazione principale

○ Nebenanwendung
Secondary application
Applicazione secondaria

TS14...-F...

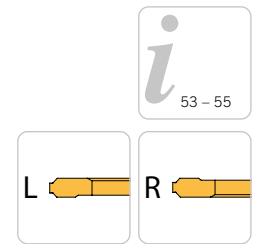
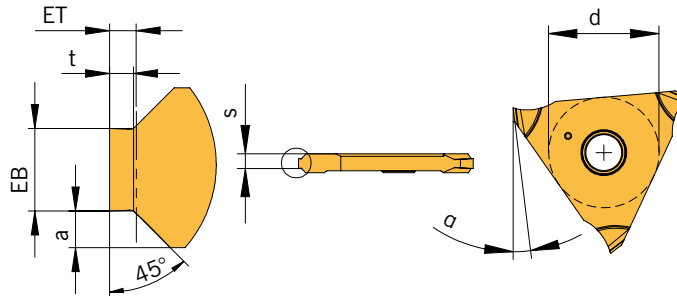

Schneideinsätze für Seegerringnuten nach DIN 471/472 Vollprofil / Inserts for circlip grooves to DIN 471/472 full profile / Inserti per gole sedi seeger DIN 471/472 profilo completo

Bezeichnung Designation Articolo	EB - 0,05	m* H13	ET	a	t	s	d	α	Größe Size Ampiezza	HC
										AP5020
TS14F-110-F020EL-GB	1,24	1,10	0,20	0,55	0,19	1,85	14	7°	F	◆
TS14F-110-F020ER-GB	1,24	1,10	0,20	0,55	0,19	1,85	14	7°	F	◆
TS14F-110-F025EL-GB	1,24	1,10	0,25	0,55	0,24	1,85	14	7°	F	◆
TS14F-110-F025ER-GB	1,24	1,10	0,25	0,55	0,24	1,85	14	7°	F	◆
TS14F-110-F030EL-GB	1,24	1,10	0,30	0,55	0,29	1,85	14	7°	F	◆
TS14F-110-F030ER-GB	1,24	1,10	0,30	0,55	0,29	1,85	14	7°	F	◆
TS14F-110-F035EL-GB	1,24	1,10	0,35	0,55	0,33	1,85	14	7°	F	◆
TS14F-110-F035ER-GB	1,24	1,10	0,35	0,55	0,33	1,85	14	7°	F	◆
TS14F-110-F040EL-GB	1,24	1,10	0,40	0,55	0,36	1,85	14	7°	F	◆
TS14F-110-F040ER-GB	1,24	1,10	0,40	0,55	0,36	1,85	14	7°	F	◆
TS14F-130-F055EL-GB	1,44	1,30	0,55	0,55	0,45	1,85	14	7°	F	◆
TS14F-130-F055ER-GB	1,44	1,30	0,55	0,55	0,45	1,85	14	7°	F	◆
TS14H-160-F070EL-GB	1,74	1,60	0,70	0,55	0,60	2,85	14	7°	H	◆
TS14H-160-F070ER-GB	1,74	1,60	0,70	0,55	0,60	2,85	14	7°	H	◆
TS14H-160-F085EL-GB	1,74	1,60	0,85	0,55	0,75	2,85	14	7°	H	◆
TS14H-160-F085ER-GB	1,74	1,60	0,85	0,55	0,75	2,85	14	7°	H	◆
TS14H-160-F100EL-GB	1,74	1,60	1,00	0,55	0,85	2,85	14	7°	H	◆
TS14H-160-F100ER-GB	1,74	1,60	1,00	0,55	0,85	2,85	14	7°	H	◆
TS14H-185-F100EL-GB	1,99	1,85	1,00	0,55	0,85	2,85	14	7°	H	◆
TS14H-185-F100ER-GB	1,99	1,85	1,00	0,55	0,85	2,85	14	7°	H	◆
TS14H-185-F125EL-GB	1,99	1,85	1,25	0,55	1,10	2,85	14	7°	H	◆
TS14H-185-F125ER-GB	1,99	1,85	1,25	0,55	1,10	2,85	14	7°	H	◆
TS14H-215-F150EL-GB	2,29	2,15	1,50	0,55	1,35	2,85	14	7°	H	◆
TS14H-215-F150ER-GB	2,29	2,15	1,50	0,55	1,35	2,85	14	7°	H	◆
TS14K-265-F150EL-GB	2,79	2,65	1,50	0,55	1,35	3,85	14	7°	K	◆
TS14K-265-F150ER-GB	2,79	2,65	1,50	0,55	1,35	3,85	14	7°	K	◆
TS14K-265-F175EL-GB	2,79	2,65	1,75	0,55	1,60	3,85	14	7°	K	◆
TS14K-265-F175ER-GB	2,79	2,65	1,75	0,55	1,60	3,85	14	7°	K	◆
TS14K-315-F175EL-GB	3,29	3,15	1,75	0,55	1,60	3,85	14	7°	K	◆
TS14K-315-F175ER-GB	3,29	3,15	1,75	0,55	1,60	3,85	14	7°	K	◆

HC = Hartmetall beschichtet / Carbide coated / Metallo duro rivestito

* Nutbreite „m“ / Groove width “m” / Larghezza di scanalatura “m”

P	●
M	○
K	○
N	○
S	○
H	○

● Hauptanwendung
Main application
Applicazione principale

○ Nebenanwendung
Secondary application
Applicazione secondaria

Werkstoffgruppe	Gliederung der Werkstoffhauptgruppen und Kennbuchstaben				Brinell-Härte	Zugfestigkeit (N/mm ²)	Zerspanungsgruppe	Schnittgeschwindigkeit Vc (m/min)	
								HC	
								AP5020	
P	Unlegierter Stahl	C ≤ 0,25 %	geglüht	125	428	P1	120 - 150 - 180		
		C > 0,25 ... ≥ 0,55 %	geglüht	190	639	P2	80 - 115 - 150		
		C > 0,25 ... ≥ 0,55 %	vergütet	210	708	P3	60 - 100 - 140		
		C ≤ 0,55 %	geglüht	190	639	P4	80 - 115 - 150		
		C ≤ 0,55 %	vergütet	300	1013	P5	60 - 100 - 140		
	Niedrig legierter Stahl	Automatenstahl (kurzspanend)		geglüht	220	745	P6	80 - 115 - 150	
				geglüht	175	591	P7	80 - 125 - 170	
				vergütet	300	1013	P8	60 - 95 - 130	
				vergütet	380	1282	P9	60 - 95 - 130	
	Hochlegierter Stahl und hochlegierter Werkzeugstahl			vergütet	430	1477	P10	60 - 90 - 120	
				geglüht	200	675	P11	80 - 110 - 140	
				gehärtet und angelassen	300	1013	P12	50 - 85 - 120	
				gehärtet und angelassen	400	1361	P13	50 - 85 - 120	
				ferritisch / martensitisch, geglüht	200	675	P14	60 - 115 - 170	
	M	Nichtrostender Stahl			330	1114	P15	50 - 75 - 100	
			200	675	M1	60 - 90 - 120			
			300	1013	M2	50 - 70 - 90			
K	Temperguss			230	778	M3	50 - 70 - 90		
				200	675	K1	-		
	Grauguss			260	867	K2	-		
				180	602	K3	-		
				245	825	K4	-		
	Gusseisen mit Kugelgraphit			155	518	K5	-		
				265	885	K6	-		
GGV (CGI)				200	675	K7	-		
N	Aluminium-Knetlegierung			30	-	N1	100 - 300 - 500		
				100	343	N2	100 - 200 - 300		
	Aluminium-Gusslegierung			75	260	N3	100 - 300 - 500		
				90	314	N4	100 - 200 - 300		
				130	447	N5	100 - 150 - 200		
	Magnesiumlegierung			70	250	N6	-		
				100	343	N7	100 - 200 - 300		
	Kupfer und Kupferlegierung (Bronze / Messing)			90	314	N8	100 - 300 - 500		
				110	382	N9	100 - 200 - 300		
				300	1013	N10	-		
		-	-	N11	80 - 130 - 180				
Nichtmetallische Werkstoffe			-	-	N12	80 - 130 - 180			
			-	-	N13	60 - 105 - 150			
			-	-	N14	60 - 105 - 150			
			-	-	N15	60 - 105 - 150			
			80 Shore	-	N16	-			
			-	-	-	-			
S	Warmfeste Legierungen	Fe-Basis		geglüht	200	675	S1	20 - 35 - 50	
		Fe-Basis		ausgehärtet	280	943	S2	20 - 30 - 40	
		Ni- oder Co-Basis		geglüht	250	839	S3	15 - 20 - 25	
		Ni- oder Co-Basis		ausgehärtet	350	1177	S4	10 - 15 - 20	
		Ni- oder Co-Basis		gegossen	320	1076	S5	10 - 15 - 20	
	Titanlegierung	Reintitan			200	675	S6	50 - 85 - 120	
		a- und β-Legierungen, ausgehärtet			375	1262	S7	30 - 40 - 50	
		β-Legierungen			410	1396	S8	25 - 35 - 45	
	Wolframlegierungen				300	1013	S9	-	
	Molybdänlegierungen				300	1013	S10	-	
H	Gehärteter Stahl	gehärtet und angelassen		50 HRC	-	H1	-		
		gehärtet und angelassen		55 HRC	-	H2	-		
		gehärtet und angelassen		60 HRC	-	H3	-		
	Gehärtetes Gusseisen		gehärtet und angelassen		55 HRC	-	H4	-	

Die Tabellenwerte sind Richtwerte.

Es kann notwendig sein, die Werte den jeweiligen Bearbeitungsumständen anzupassen.

HC = Hartmetall beschichtet

Material group	Structure of the material groups and identification letters		Brinell hardness HB	Tensile strength Rm (N/mm ²)	Chipping group	Cutting speed Vc (m/min)	
						HC	
						AP5020	
P	Unalloyed steel	C ≤ 0.25 % annealed	125	428	P1	120 - 150 - 180	
		C >= 0.25 ... >= 0.55 % annealed	190	639	P2	80 - 115 - 150	
		C >= 0.25 ... >= 0.55 % hardened and tempered	210	708	P3	60 - 100 - 140	
		C ≤ 0.55 % annealed	190	639	P4	80 - 115 - 150	
		C ≤ 0.55 % hardened and tempered	300	1013	P5	60 - 100 - 140	
		Machinig steel (short-clipping) annealed	220	745	P6	80 - 115 - 150	
	Low alloyed steel	annealed	175	591	P7	80 - 125 - 170	
		hardened and tempered	300	1013	P8	60 - 95 - 130	
		hardened and tempered	380	1282	P9	60 - 95 - 130	
		hardened and tempered	430	1477	P10	60 - 90 - 120	
	High alloyed steel and high alloyed tool steel	annealed	200	675	P11	80 - 110 - 140	
		hardened	300	1013	P12	50 - 85 - 120	
		hardened	400	1361	P13	50 - 85 - 120	
	Stainless steel	ferretic / martensitic, annealed	200	675	P14	60 - 115 - 170	
		martensitic, hardened and tempered	330	1114	P15	50 - 75 - 100	
M	Stainless steel	austenitic, chilled	200	675	M1	60 - 90 - 120	
		austenitic, precipitation-hardened (PH)	300	1013	M2	50 - 70 - 90	
		austenitic-ferritic, Duplex	230	778	M3	50 - 70 - 90	
K	Malleable cast iron	ferritic	200	675	K1	-	
		pearlitic	260	867	K2	-	
	Cast iron	low tensile strength	180	602	K3	-	
		high tensile strength / austenitic	245	825	K4	-	
		ferritic	155	518	K5	-	
	Cast iron with nodular graphite	pearlitic	265	885	K6	-	
		GGV (CGI)	200	675	K7	-	
N	Aluminium alloys long chipping	not heat treatable	30	-	N1	100 - 300 - 500	
		heat treatable, heat treated	100	343	N2	100 - 200 - 300	
		≤ 12 % Si, not heat treatable	75	260	N3	100 - 300 - 500	
	Casted aluminium alloys	≤ 12 % Si, heat treatable, heat treated	90	314	N4	100 - 200 - 300	
		> 12 % Si, not heat treatable	130	447	N5	100 - 150 - 200	
	Magnesium alloys	> 12 % Si, not heat treatable	70	250	N6	-	
	Copper and copper alloys (Brass / Bronze)	Unalloyed, elektrolyte copper	100	343	N7	100 - 200 - 300	
		Brass, Bronze	90	314	N8	100 - 300 - 500	
		Cu-alloys, short-chipping	110	382	N9	100 - 200 - 300	
			300	1013	N10	-	
						-	
	Non-ferrous materials	Lead alloys (without abrasive filling material)	-	-	N11	80 - 130 - 180	
		Duroplastic (without abrasive filling material)	-	-	N12	80 - 130 - 180	
		Plastic glas fibre reinforced GFRP	-	-	N13	60 - 105 - 150	
		Plastic carbon fibre reinforced CFRP	-	-	N14	60 - 105 - 150	
		Plastic aramid fibre reinforced AFRP	-	-	N15	60 - 105 - 150	
Graphite (tech.)		80 Shore	-	N16	-		
S	High temperature resistant alloys	Fe-based annealed	200	675	S1	20 - 35 - 50	
		Fe-based heat treated	280	943	S2	20 - 30 - 40	
		Ni- or Co-alloyed annealed	250	839	S3	15 - 20 - 25	
		Ni- or Co-alloyed heat treated	350	1177	S4	10 - 15 - 20	
		Ni- or Co-alloyed casting	320	1076	S5	10 - 15 - 20	
	Titanium alloys	Pure titan	200	675	S6	50 - 85 - 120	
		α- and β-alloys, heat treated	375	1262	S7	30 - 40 - 50	
		β-alloys	410	1396	S8	25 - 35 - 45	
	Wolfram alloys		300	1013	S9	-	
	Molybdän alloys		300	1013	S10	-	
H	Hardened steel	hardened	50 HRC	-	H1	-	
		hardened	55 HRC	-	H2	-	
		hardened	60 HRC	-	H3	-	
	Hardened cast iron	hardened	55 HRC	-	H4	-	

The recommended cutting data are only approximate values.
 It may be necessary to adjust them to each individual machining application.
 HC = Carbide coated

Gruppo materiale	Struttura dei gruppi di materiali e lettere di riferimento		Durezza Brinell	Resistenza Rm (N/mm ²)	Gruppo di lavoro	Velocità di taglio Vc (m/min)	
						HC	
						AP5020	
P	Acciai non legato	C ≤ 0,25 % ricotto	125	428	P1	120 - 150 - 180	
		C > 0,25 ... >= 0,55 % ricotto	190	639	P2	80 - 115 - 150	
		C > 0,25 ... >= 0,55 % bonificato	210	708	P3	60 - 100 - 140	
		C ≤ 0,55 % ricotto	190	639	P4	80 - 115 - 150	
		C ≤ 0,55 % bonificato	300	1013	P5	60 - 100 - 140	
	Acciai debolmente legati	Acciaio (truciolo corto) ricotto	220	745	P6	80 - 115 - 150	
		ricotto	175	591	P7	80 - 125 - 170	
		bonificato	300	1013	P8	60 - 95 - 130	
		bonificato	380	1282	P9	60 - 95 - 130	
	Acciai fortemente legati e acciai da utensili	bonificato	430	1477	P10	60 - 90 - 120	
		ricotto	200	675	P11	80 - 110 - 140	
		temprato e rinvenuto	300	1013	P12	50 - 85 - 120	
	Acciai inossidabili	temprato e rinvenuto	400	1361	P13	50 - 85 - 120	
		ferritico / martensitico, ricotto	200	675	P14	60 - 115 - 170	
	M	Acciai inossidabili	martensitico, bonificato	330	1114	P15	50 - 75 - 100
austenitico, trattato o temerato			200	675	M1	60 - 90 - 120	
austenitico, indurimento per precipitazione (PH)			300	1013	M2	50 - 70 - 90	
K	Ghisa temprata	austenitico-ferritico, Duplex	230	778	M3	50 - 70 - 90	
		ferritico	200	675	K1	-	
	Ghisa grigia	perlitica	260	867	K2	-	
		bassa resistenza	180	602	K3	-	
		alta resistenza / austenitico	245	825	K4	-	
	Ghisa sferoidale	ferritico	155	518	K5	-	
		perlitica	265	885	K6	-	
GGV (CGI)		200	675	K7	-		
N	Leghe di Alluminio stampato	non invecchiato	30	-	N1	100 - 300 - 500	
		rinvenuto, invecchiato	100	343	N2	100 - 200 - 300	
	Leghe di Alluminio da fusione	≤ 12 % Si, non invecchiato	75	260	N3	100 - 300 - 500	
		≤ 12 % Si, rinvenuto, invecchiato	90	314	N4	100 - 200 - 300	
	Leghe di magnesio	> 12 % Si, non invecchiato	130	447	N5	100 - 150 - 200	
		> 12 % Si, non invecchiato	70	250	N6	-	
	Rame e Leghe di Rame (Bronzo / Ottone)	Non legati, Rame Elettrolitico	100	343	N7	100 - 200 - 300	
		Ottone, Bronzo	90	314	N8	100 - 300 - 500	
		Leghe Cu, truciolo corto	110	382	N9	100 - 200 - 300	
			300	1013	N10	-	
	Materiali non metallici	Leghe al piombo (senza materiale di riempimento abrasivo)	-	-	N11	80 - 130 - 180	
Duroplastico (senza materiale di riempimento abrasivo)		-	-	N12	80 - 130 - 180		
Plastica rinforzata in fibra di vetro GFRP		-	-	N13	60 - 105 - 150		
Plastica rinforzata in fibra di carbonio CFRP		-	-	N14	60 - 105 - 150		
Plastica rinforzata in fibra aramidica AFRP		-	-	N15	60 - 105 - 150		
Grafite (tecnico)		80 Shore	-	N16	-		
S	Leghe resistenti al calore	Base-Fe ricotto	200	675	S1	20 - 35 - 50	
		Base-Fe invecchiato	280	943	S2	20 - 30 - 40	
		Base Ni o Co ricotto	250	839	S3	15 - 20 - 25	
		Base Ni o Co invecchiato	350	1177	S4	10 - 15 - 20	
		Base Ni o Co da fusione	320	1076	S5	10 - 15 - 20	
	Leghe di Titanio	Titanio puro	200	675	S6	50 - 85 - 120	
		Leghe α e β, invecchiato	375	1262	S7	30 - 40 - 50	
		Leghe β	410	1396	S8	25 - 35 - 45	
	Leghe di tungsteno		300	1013	S9	-	
	Leghe di molibdeno		300	1013	S10	-	
H	Acciaio Temprato	temprato e rinvenuto	50 HRC	-	H1	-	
		temprato e rinvenuto	55 HRC	-	H2	-	
		temprato e rinvenuto	60 HRC	-	H3	-	
	Ghisa Temprata	temprato e rinvenuto	55 HRC	-	H4	-	

I dati indicati in tabella sono valori approssimati.

Può essere necessario adattarli alle singole applicazioni di lavorazione.

HC = Metallo duro rivestito

Einsatzempfehlung / Application recommendations / Consigli di utilizzo

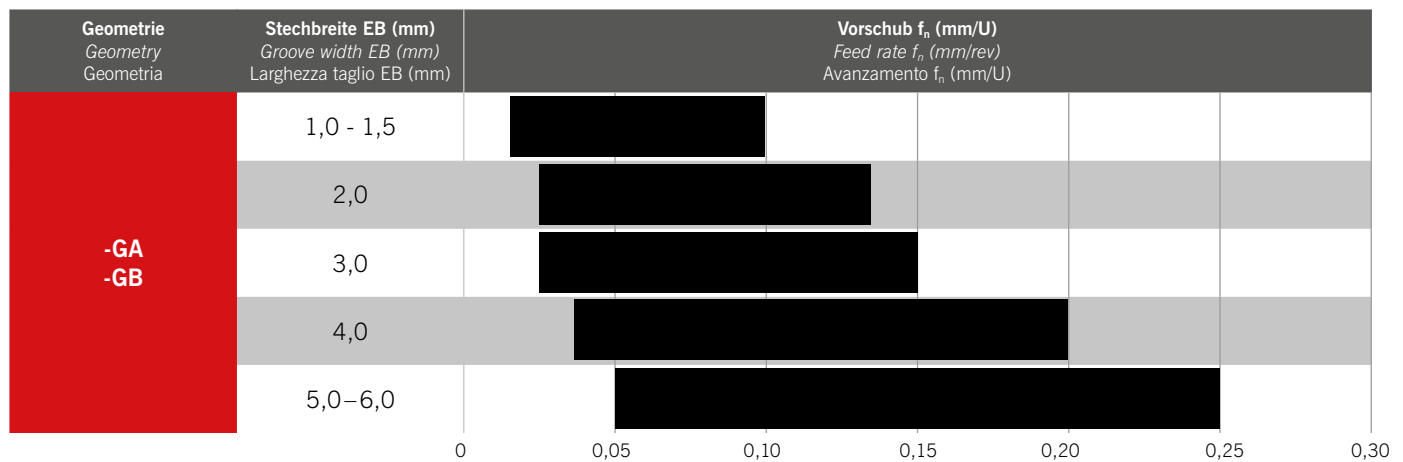

Stechtiefe in Abhängigkeit von D_{max}

Cutting depth dependent on D_{max}

Larghezza gola in funzione di D_{max}

Stechtiefe (mm) Groove depth (mm) Larghezza gola (mm)	HTE-1616-...	HTE-2020-...	HTE-2525-...
ET	D_{max}		
2,0	∞	∞	∞
2,5	∞	∞	∞
3,0	935	935	∞
3,5	360	360	∞
4,0	220	220	945
4,5	160	160	450
5,0	125	125	300
5,5	105	105	220
6,0	90	90	180
6,5	80	80	150

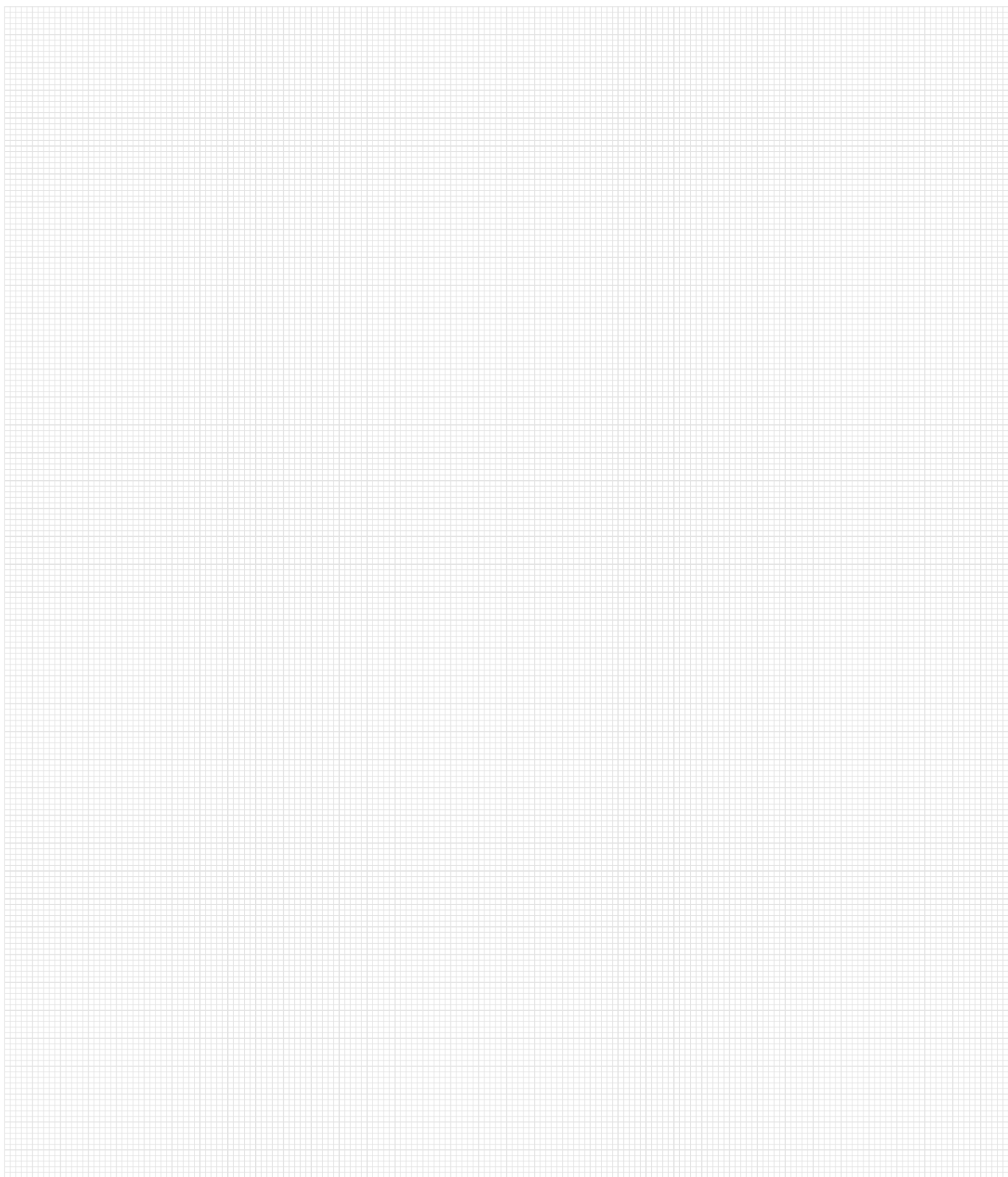

Weitere Informationen finden Sie unter
For more information see
Per maggiori informazioni visita il sito

www.arno.de

ARNO®

WERKZEUGE

ARNO-2021-06-ATS-DEI

HERAUSRAGEND VIELSEITIG UND INNOVATIV.

Kurz- oder Langdrehen, Stechen, Drehen, Bohren oder Fräsen: Was auch immer Sie vorhaben – es lohnt sich, bei ARNO vorbeizuschauen. Wir haben für fast jeden Anwendungsfall in der Zerspanung eine Lösung. Mit der richtigen Mischung aus Erfahrung, Pioniergeist und Qualität sorgen wir dafür, dass Sie mit passgenauen Werkzeugsystemen, Toolmanagement-Lösungen und cleveren Innovationen das Beste aus Ihrer Fertigung rausholen.

Mehr Infos zu unseren innovativen Systemen finden Sie unter www.arno.de

OUTSTANDING VERSATILE AND INNOVATIVE.

Turning or Swiss type turning, grooving, drilling or milling: whatever your requirements are, it's worth your while to take a look at ARNO. We have a solution for almost every metal-working application. We have the right mix of experience, pioneering spirit and quality to ensure that you get the best out of your production with the right tool systems, tool management solutions and clever innovations.

For more details on our innovative systems, go to www.arno-tools.co.uk / www.arnousa.com

ECCEZIONALE VERSATILE ED INNOVATIVO.

Tornitura o fantina mobile, scanalatura, foratura o fresatura: qualunque siano le tue esigenze, vale sempre la pena considerare ARNO. Abbiamo tantissime soluzioni per la lavorazione dei tuoi materiali. Abbiamo il giusto mix di esperienza, spirito pionieristico e qualità per assicurarti di ottenere il meglio dalla tua produzione con gli utensili corretti, soluzioni di gestione degli utensili e innovazioni tecniche intelligenti.

Per maggiori dettagli, visita il sito www.arno-italia.it

Karl-Heinz Arnold GmbH

Karlsbader Str. 4 | D-73760 Ostfildern | Tel +49 (0)711 34 8020 | Fax +49 (0)711 34 802 130 | anfrage@arno.de | bestellung@arno.de